

Platine Terminal AXEL

Serial and TCP/IP Models

Programmer's Guide

February 2000 - Ref.: AXPRGE832-4

The reproduction of this material, in part or whole, is strictly prohibited. For additional information, please contact:

AXEL

16 Avenue du Québec
Bât. M1 EVOLIC - BP 728
91962 Courtabœuf cedex - FRANCE
Tel.: +33 1.69.28.27.27
Fax: +33 1.69.28.82.04
Email: info@axel.fr

The information in this document is subject to change without notice. AXEL assumes no responsibility for any errors that may appear in this document.

All trademarks and registered trademarks are the property of their respective holders.

© - 1998-2000 - AXEL - All Rights Reserved.

| | |
|--|-----------|
| 1 - ABOUT THIS MANUAL | 1 |
| 1.1 - ORGANISATION..... | 2 |
| 1.2 - AVAILABLE EMULATIONS ACCORDING TO THE MODEL..... | 2 |
| 1.3 - FIRMWARE REVISION | 4 |
| 1.3.1 - Hardware Information..... | 4 |
| 1.3.2 - Firmware Information | 4 |
| 2 - TERMINAL COMMANDS | 7 |
| 2.1 - ANSI FAMILY | 8 |
| 2.2 - VT FAMILY..... | 16 |
| 2.3 - WYSE 60 EMULATION | 24 |
| 2.4 - PCTERM FAMILY | 31 |
| 2.5 - SM94XX FAMILY | 35 |
| 2.6 - PROLOGUE FAMILY..... | 35 |
| 2.7 - QVT119+ EMULATION..... | 36 |
| 2.8 - TVI EMULATION..... | 40 |
| 2.9 - 3151 EMULATION | 43 |
| 3 - CHARACTER SETS..... | 47 |
| 3.1 - ANSI, PCTERM, SM94xx, PROLOGUE, QVT, TVI, 3151 | 48 |
| 3.2 - VT FAMILY..... | 61 |
| 3.3 - WYSE FAMILY..... | 65 |
| 4 - KEYBOARDS..... | 70 |
| 4.1 - NATIONAL KEYBOARDS..... | 71 |
| 4.2 - PROGRAMMING KEYS | 83 |
| 4.2.1 - ANSI Family..... | 85 |
| 4.2.2 - VT Family | 93 |
| 4.2.3 - WYSE Emulation..... | 100 |
| 4.2.4 - PCTERM Family..... | 101 |
| 4.2.5 - SM94xx Family | 102 |
| 4.2.6 - PROLOGUE Family | 105 |
| 4.2.7 - QVT119+ Emulation | 106 |
| 4.2.8 - TVI Emulation | 107 |
| 4.2.9 - 3151 Emulation..... | 108 |
| 4.3 - COMPOSITE CHARACTERS..... | 109 |
| 4.3.1 - Standard Processing..... | 110 |
| 4.3.2 - Local Processing | 110 |
| 4.3.3 - Remote Processing..... | 111 |

- 1 -
ABOUT THIS MANUAL

Organisation of the manual and available emulations.

1.1 - ORGANISATION

This manual provides detailed information on AX3000 terminal and its features. This manual has three chapters:

- **terminal commands**: an exhaustive list of escapes sequences supported by the AX3000 emulations,
- **character sets**: description of character sets,
- **keyboards**: description of available national keyboards, list of the default values for programming keys corresponding to the selected emulation and information about dead keys.

1.2 - AVAILABLE EMULATIONS ACCORDING TO THE MODEL

Several emulations are provided by the AX3000. The available emulations depend on the AX3000 model (serial or Ethernet TCP/IP).

Further more, emulations are grouped by family. These emulation families are used in the following chapters.

The following table lists the available emulations (sorted by family) according to the AX3000 models:

| Emulation Families | Emulations | AX3000 Models | |
|--------------------|----------------------------|---------------|--------|
| | | Serial | TCP/IP |
| ANSI | ANSI | yes | yes |
| | XENIX SCO | yes | yes |
| | UNIX SCO 3.2.2 | yes | yes |
| | UNIX SCO 3.2.4 | yes | yes |
| | SCO OPENSERVR | yes | yes |
| | ANSI DOS | yes | yes |
| | UNIX SVR4 | yes | yes |
| | ANSI INTERACTIVE | yes | yes |
| | ANSI RS6000 | yes | yes |
| | ANSI MOS | yes | yes |
| | ANSI DATA GENERAL | --- | yes |
| | ANSI SLNET | --- | yes * |
| | UNIXWARE 7 | --- | yes |
| LINUX | --- | yes | |
| VT | VT220 | yes | yes |
| | HFT | yes | yes |
| | VT AS400 | --- | yes |
| WYSE | WYSE 60 | yes * | yes * |
| PCTERM | PCTERM | yes | yes * |
| | PCTERM THEOS | yes | yes * |
| | OS2 POLYMOD2 | yes | yes * |
| SM94xx | SM9400 et SM9412 | yes * | yes * |
| TVI | TVI | --- | yes * |
| QVT | QVT119+ | --- | yes * |
| 3151 | 3151 | --- | yes * |
| Prologue | PROLOGUE 2/3, PROLOGUE 4/5 | yes | --- |
| | TWIN SERVER | yes | yes * |

(*) optional

1.3 - FIRMWARE REVISION

The AX3000 firmware revision is composed by:

- an hardware information
- a firmware information

1.3.1 - Hardware Information

The AX3000 hardware information is:

FKx-BVyyy

- **FKx** is the electronic board code
- **BVyyy** is the boot code version (the boot code is the non-erasable part of the flash memory)

Examples:

FK3-BV11f
FK5-BV12a

1.3.2 - Firmware Information

a) General Information

The beginning of the firmware version is:

FCT.NA.aassi

- **FCT** is the AX3000 operating mode:
 - TCP stands for both TCP/IP and serial modes,
 - SER stands for serial mode.
- **NA** is the firmware nationality (code is ISO compliant). The main nationalities are:
 - FR: France - XX: International
 - GR: Greece - TR: Turkey
 - FI: Finland - PT: Portugal
- **aassi** is the year and the week number of the firmware creation following by an alphabetical index (for instance: 9832f).

Note: Three parameters depend on the firmware nationality:

- the set-up message nationality (FR: French messages, other: English messages),
- the possible presence of a national keyboard and associated character set. For instance, the Turkish environment (keyboards and character set) is only available with the 'TR' firmware.
- the default keyboard nationality (FR: France, XX: North American, TR: Turkey, etc).

b) Possible Firmware Options

If no option are included, the general firmware information is followed by ':STD'. Else, options, encoded by 3 characters, follow the general firmware information. A '&' is used as a separator.

The main firmware options are:

| | |
|--------------------------------------|----------------------------|
| WYS : Wyse 60/120 emulation | ATO : ATO300 emulation |
| SM9 : SM9400/SM9412 emulation | THE : Theos emulation |
| QVT : QVT 119+ emulation | TVI : TVI 910 emulation |
| SLN : SLNET emulation | I51 : 3151 emulation |
| ALG : alpha-graphics mode | EUR : Euro currency symbol |
| F24 : 24-fctn-keys keyboard (AS/400) | MSE : mouse support |

Note: some options are incompatible (ex.: WYS and I51).

Examples:

```
FK3-BV11f/TCP.FR.9832f:STD
FK5-BV12a/TCP.XX.9832f:WYS&EUR
```

- 2 -
TERMINAL COMMANDS

This chapter describes supported terminal commands for each emulation.

A terminal command is a character string. Terminal commands perform special actions (moving the cursor, setting reverse mode, etc). Generally such a sequence contains only 1 unprintable ASCII character (smaller than 20h). All other characters are printable (greater than 20h).

Conventions:

- **xxh**: xx is the hexadecimal ASCII character (ex: 1Bh is 27 decimal),
- **Esc** is 1Bh,
- **CSI** is the both ASCII characters 'Esc [' (1Bh and 5Bh).

2.1 - ANSI FAMILY

Note: for the 4 SCO emulations and the LINUX emulation, CSI can also be obtained by the 9Bh ASCII character (instead of the Esc [ASCII characters).

Controlling the Cursor

| | |
|--------------------------------------|------------------------|
| Cursor right Pn columns | CSI Pn C (or CSI Pn a) |
| Cursor left | 08h |
| Cursor left Pn columns | CSI Pn D |
| Cursor up | Esc M |
| Cursor up Pn lines | CSI Pn A |
| Cursor up Pn lines and to column 1 | CSI Pn F |
| Cursor down | Esc D (or 0Ah) |
| Cursor down Pn lines | CSI Pn B (or CSI Pn e) |
| Cursor down Pn lines and to column 1 | CSI Pn E |
| Cursor to column Pn | CSI Pn G (or CSI Pn `) |
| Cursor to line Pn | CSI Pn d |

| | |
|--|-------------------------------------|
| Cursor to line Pn1 (1..25) column Pn2 (1..132) | CSI Pn1;Pn2 H (or CSI Pn1;Pn2 f) |
| Cursor to start of line (or to start of next line) | 0Dh |
| Save cursor position | CSI s (or Esc 7) |
| Restore cursor to saved position | CSI u (or Esc 8) |
| Disable cursor | CSI < 0 @ |
| Enable cursor | CSI < 1 @ |
| Controlling the Terminal | |
| Sound bell | 07h |
| Set scrolling region (beginning line number, ending line number) | CSI Pn1;Pn2 r |
| Terminal mode on | CSI Ps;...Ps h |
| Ps = 2: lock keyboard | |
| Ps = 4: insert character mode | |
| Ps = 20: new line (LF=CR+LF) | |
| Ps = 32: lock keyboard and send ACK (06h) | |
| Ps = 33: autoscrolling mode on | |
| Ps = ?3: set 132-column display | |
| Ps = ?6: origin is scrolling region | |
| Ps = ?7: autowrap mode on | |
| Terminal mode off | CSI Ps;...Ps l* |
| Ps = 2: unlock keyboard | |
| Ps = 4: replace character mode | |
| Ps = 20: line feed | |
| Ps = 33: autoscrolling mode off | |
| Ps = ?3: set 80-column display | |
| Ps = ?6: origin is screen | |
| Ps = ?7: autowrap mode off | |
| PC-scancode mode | CSI < 0 A |
| ASCII mode | CSI < 1 A |
| Display 24 data lines + 1 message line | CSI < 0 l** |
| Display 25 data lines | CSI < 1 l |
| Enable main screen (24 lines) | CSI < 0 E |
| Enable message line (25 th . line) | CSI < 1 E |
| Disable colouring feature | CSI < 0 G |
| Enable colouring feature | CSI < 1 G |

* The last character in this sequence is a lowercase l

** The last character in this sequence and in the next sequence is an uppercase i

| | | |
|--|--|--------------------------------------|
| Set colours and enable colouring mode (4 pairs) | CSI < 2;Cn1;...;Cn8 G | |
| Set a VGA palette colour | CSI < 3;Cn;Pn G | |
| Enable private enhanced AXEL ANSI sequence mode | CSI < 0 B | |
| Disable private enhanced AXEL ANSI sequence mode | CSI < 1 B | |
| Save current setting and set UNIX SCO 3.2.2 personality | CSI < 0 H | |
| Restore saved setting | CSI < 1 H | |
| Active la vue Pn | CSI Pn z | |
| Enable monitor mode | Esc U | |
| Disable monitor mode | Esc X | |
| Miscellaneous actions | CSI = Pn L | |
| Pn=0: a cleared area (CSI Pn J, CSI Pn K or scroll) is filled with the current video attribute | | |
| Pn=1: a cleared area (CSI Pn J, CSI Pn K or scroll) is filled with the normal video attribute | | |
| Pn=2: the CSI Pn g sequence is equal to CSI = Pn g (see Editing section) | | |
| Pn=3: the CSI Pn g sequence is behavior is defined in the Editing section | | |
| Change page (only if '4 views, 2 pages' is selected through the set-up) | CSI < Ps1;Ps2 L | |
| Ps1 = 0: regular page changing | Ps2 = 0: enable next page | |
| Ps1 = 1: copy current page to wanted page before swap | Ps2 = 1: enable page number 1 | |
| Ps1 = 2: clear wanted page before swap | Ps2 = 2: enable page number 2 | |
| Turn keyboard LEDs on or off | CSI < Pn1;Pn2;Pn3 O | |
| Pn1 is the state of NUM LED, Pn2 is the state of CAPS LED and Pn3 is the state of SCROLL LED. | | |
| The Pn parameter values should be: | | |
| Pn = 0: the state of the LED (on or off) is not modified | | |
| Pn = 1: turn the LED on | | |
| Pn = 2: turn the LED off | | |
| Mouse feature (if set through the set-up) | CSI < Pn M* | |
| Pn = 0: disable mouse | Pn = 1: local mode | Pn = 2: raw mode |
| Axel bitmap graphics functions | CSI < Ps;...Ps K** | |
| Font downloading (if set through the set-up) | CSI < Ps;...Ps N | |
| Double-size characters (if set through the set-up) | CSI < Pn Q term mess term | |
| Pn = 1: double height | Pn = 2: double width | Pn = 3: double height / double width |
| term: message terminator | message: character string displayed in double size | |

* For more information, refer the concerned literature

** For more information, refer the concerned literature

Controlling Character Attributes

| | |
|---|----------------|
| Definition | CSI Ps;...Ps m |
| Ps = 0: all attributes off | |
| Ps = 1: bold | |
| Ps = 4: underline (only monochrome VGA monitor) | |
| Ps = 5: blinking | |
| Ps = 7: reverse video | |
| Ps = 8: blank | |
| Ps = 10: selects the primary font | |
| Ps = 11: selects the first alternate font; lets ASCII characters less than 32 be displayed as ROM characters | |
| Ps = 12: selects a second alternate font; toggles high bit of extended ASCII code before displaying as ROM characters | |
| Ps = 22: bold off | |
| Ps = 24: blinking off | |
| Ps = 25: underline off | |
| Ps = 27: reverse video off | |
| Ps = 3x: set foreground colour to colour x (x from 0 to 7) | |
| 0: black 1: red 2: green 3: brown* | |
| 4: blue 5: magenta 6: cyan 7: white | |
| Ps = 38: enable underline option | |
| Ps = 39: disable underline option | |
| Ps = 4x: set background colour to colour x (x from 0 to 7) | |
| 0: black 1: red 2: green 3: brown | |
| 4: blue 5: magenta 6: cyan 7: white | |

Editing

| | |
|---|-----------|
| Set tab stop at cursor position | Esc H |
| Move cursor to next tab stop | 09h |
| Move cursor backward Pn tab stops | CSI Pn Z |
| Clear tab stop at cursor position | CSI 0g |
| Clear all tab stops | CSI 3g |
| Display ASCII character Pn | CSI =Pn g |
| Insert Pn null characters beginning at cursor position | CSI Pn @ |
| Insert Pn lines of null characters beginning at cursor line | CSI Pn L |
| Display Pn times, the last displayed character | CSI Pn b |

* Yellow for ANSI RS6000 emulation

Erase display:

| | |
|------------------------------------|---------|
| from cursor to end of screen | CSI 0 J |
| from beginning of screen to cursor | CSI 1 J |
| entire screen | CSI 2 J |

Erase line:

| | |
|------------------------------|---------|
| from cursor to end of line | CSI 0 K |
| from start of line to cursor | CSI 1 K |
| entire line | CSI 2 K |

Delete Pn characters beginning at cursor position CSI Pn P

Delete Pn lines beginning at cursor line CSI Pn M

Erase Pn character beginning at cursor column CSI Pn X

Printing Control Sequences

Select the default printer port: CSI < Po F

| | | | |
|----------------|--------------|------------------|------------------|
| TCP/IP models: | Po = 1: AUX1 | Po = 2: AUX2 | Po = 3: parallel |
| Serial models: | Po = 1: AUX1 | Po = 2: parallel | |

Using default port (serial or parallel): CSI Pn i

Pn = 0: Print screen Pn = 5: Enable local printing mode Pn = 4: Disable local printing mode

Enable Po auxiliary port for sending only (disable: CSI 4i) CSI < 5; Po C

Enable receive mode of Po auxiliary port (AUX1 or AUX2) CSI < 5; Po D

Disable receive mode of Po auxiliary port (AUX1 or AUX2) CSI < 4; Po D

| | | | | |
|----------------|----------------------|--------------|------------------|------------------|
| TCP/IP models: | Po = 0: default port | Po = 1: AUX1 | Po = 2: AUX2 | Po = 3: parallel |
| Serial models: | Po = 0: default port | Po = 1: AUX1 | Po = 2: parallel | |

Programming Function KeysANSI mode: Esc Q Code Terminator Message Terminator

- Code: function key (<F1> = 0 (30h) ... <F61> = l (6Ch))
- Terminator: one character (>20h)
- Message: key definition (any character except Terminator). Character '^' (5Eh) indicates 20h must be subtracted from the next character.

Example: **ESC Q 0 amenu^a**, <F1> sends **menu <RC>**AXEL mode: CSI < Code P Terminator Message Terminator

- Code: function key (refer to appendix A.3 or see the AX3000 set-up)
- Terminator: one character (>20h)
- Message: key definition (any character except Terminator). Character '^' (5Eh) indicates 20h must be subtracted from the next character.

Example: **CSI < 1 P amenu^a**, <F1> sends **menu <RC>**

Additional Screen Attributes Sequences (except ANSI DOS)

| | |
|---|-----------------|
| Set overscan colour to colour Cn (64 colours are available) | CSI = Cn A |
| VGA mode 'blink' (8 background colours) | CSI = D |
| VGA mode 'bold' (16 background colours) | CSI = E |
| Set normal foreground colour to Cn | CSI = Cn F* |
| Set normal background colour to Cn | CSI = Cn G |
| Set normal foreground colour to Cn1 and background colour to Cn2 | CSI 2;Cn1;Cn2 m |
| Set reverse foreground colour to Cn | CSI = Cn H |
| Set reverse background colour to Cn | CSI = Cn I |
| Set reverse foreground colour to Cn1 and background colour to Cn2 | CSI 7;Cn1;Cn2 m |
| Set graphic foreground colour to Cn | CSI = Cn J |
| Set graphic background colour to Cn | CSI = Cn K |
| For XENIX personality only: VGA mode 'bold' (16 background colours) | CSI 3;0 m |
| For XENIX personality only: VGA mode 'blink' (8 background colours) | CSI 3;1 m |
| Set cursor size (P1 upper microline, P2 lower microline) | CSI = P1;P2 C |
| Save current colour setting | CSI = Y |
| Restore saved colour setting | CSI = Z |

Reports

| | |
|--|------------------------|
| AX3000 IP address | CSI < a (or CSI < 0 a) |
| Response: IP address <CR> | |
| Firmware revision | CSI < 1 a |
| Response: version <CR> | |
| Answerback message (set through the AX3000 Set-Up) | CSI < 4 a |
| Response: message | |
| Current session number | CSI < 5 a |
| Response: number <CR> | |
| Printer Status | CSI < 6 a |
| Response: OK <CR> or ERR <CR> | |

TCP/IP Status Line (set the associated label)

Syntax is: CSI < c Terminator Message Terminator

- Terminator: one character (>20h)
- Message: session label.

Example: **CSI <czview 1z**

* In this sequence and in the next 7 sequences, Cn value is in range 0 to 15

Private Enhanced AXEL ANSI Sequence Mode

The following sequences, derived from native personalities, may be used to speed up the display on a Platine terminal. These sequences are shorter than their equivalent ANSI sequences.

| Description | Sequence | Equivalent ANSI Seq. |
|--|-------------------|----------------------|
| Cursor up | 05h | CSI B |
| Cursor right | 06h | CSI C |
| Cursor left | 08h | CSI D |
| Cursor down | 0Bh | CSI A |
| Clear screen | 0Eh | CSI H CSI 2J |
| Cursor to line 1 column 1 | 1Eh | CSI H |
| Insert a null character | Esc @ | CSI @ |
| Erase display from cursor to end of screen | Esc J | CSI J |
| Erase line from cursor to end of line | Esc K | CSI K |
| Insert a line of null characters | Esc L | CSI L |
| Delete current line | Esc M | CSI M |
| Delete 1 character | Esc P | CSI P |
| Start local printing mode | Esc ' | CSI 5i |
| Stop local printing mode | Esc ²² | CSI 4i |
| All attributes off | Esc a | CSI 0m |
| Reverse video | Esc b | CSI 7m |
| Blinking | Esc c | CSI 5m |
| Underline | Esc d | CSI 4m |
| Cursor to line L and column C | Esc f L C | CSI L+33;C+33 H |
| Bold | Esc h | CSI 1m |
| Default attribute | Esc p | CSI 7m |
| Enable cursor | Esc v | CSI <1@ |
| Disable cursor | Esc w | CSI <0@ |
| Black foreground | Esc r 0 | CSI 22;30m |
| Red foreground | Esc r 1 | CSI 22;31m |
| Green foreground | Esc r 2 | CSI 22;32m |
| Brown foreground | Esc r 3 | CSI 22;33m |
| Blue foreground | Esc r 4 | CSI 22;34m |
| Magenta foreground | Esc r 5 | CSI 22;35m |
| Cyan foreground | Esc r 6 | CSI 22;36m |
| White foreground | Esc r 7 | CSI 22;37m |
| Grey foreground | Esc r 8 | CSI 1;30m |
| Light red foreground | Esc r 9 | CSI 1;31m |

| Description | Sequence | Equivalent ANSI Seq. |
|---|-----------|----------------------|
| Light green foreground | Esc r A | CSI 1;32m |
| Yellow foreground | Esc r B | CSI 1;33m |
| Light blue foreground | Esc r C | CSI 1;34m |
| Light magenta foreground | Esc r D | CSI 1;35m |
| Light cyan foreground | Esc r E | CSI 1;36m |
| Bright white foreground | Esc r F | CSI 1;37m |
| Black background | Esc s 0 | CSI 40m |
| Red background | Esc s 1 | CSI 41m |
| Green background | Esc s 2 | CSI 42m |
| Brown background | Esc s 3 | CSI 43m |
| Blue background | Esc s 4 | CSI 44m |
| Magenta background | Esc s 5 | CSI 45m |
| Cyan background | Esc s 6 | CSI 46m |
| White background | Esc s 7 | CSI 47m |
| Cursor to line L and column C | Esc ũ L C | CSI L+33;C+33 |
| Reverse video | Esc é | CSI 7m |
| Reverse video off | Esc â | CSI 27m |
| Blinking | Esc ä | CSI 5m |
| Bold off | Esc à | CSI 22m |
| Blinking off | Esc â | CSI 25m |
| Bold | Esc ç | CSI 1m |
| Set foreground colour to x and background colour to y | Esc ê x y | CSI 3x;4ym |
| x and y available values: | | |
| 0: black | 1: red | 2: green |
| 3: brown | 4: blue | 5: magenta |
| 6: cyan | 7: white | |
| Delete current line | Esc ë | CSI M |
| Insert a line of null characters | Esc è | CSI L |
| Enable message line (25 th line) | Esc ï | CSI <1E |
| Enable main screen (24 lines) | Esc î | CSI <0E |
| Delete a character | Esc ì | CSI P |
| Insert a null character | Esc Ä | CSI @ |
| Erase line from cursor to end of line | Esc Å | CSI K |
| Erase display from cursor to end of screen | Esc É | CSI J |

2.2 - VT FAMILY

Note: this family is composed by the VT220, HFT and VT AS400 emulations.

Controlling the Cursor

| | |
|--|-------------------------------------|
| Cursor right Pn columns | CSI Pn C |
| Cursor left | 08h |
| Cursor left Pn columns | CSI Pn D |
| Cursor up | Esc M |
| Cursor up Pn lines | CSI Pn A |
| Cursor down | Esc D (or 0Ah) |
| Cursor down Pn lines | CSI Pn B |
| Cursor down Pn lines and to column 1 | Esc E |
| Carriage return (and line feed according to the AX3000 set-up) | 0Dh |
| Cursor to line Pn1 (1..25) column Pn2 (1..132) | CSI Pn1;Pn2 H (or CSI Pn1;Pn2 f) |

Editing

| | |
|---|----------|
| Set tab stop at cursor position | Esc H |
| Move cursor to next tab stop | 09h |
| Clear tab stop at cursor position | CSI 0g |
| Clear all tab stops | CSI 3g |
| Insert Pn null characters beginning at cursor position | CSI Pn @ |
| Insert Pn lines of null characters beginning at cursor line | CSI Pn L |
| Delete Pn characters beginning at cursor position | CSI Pn P |
| Delete Pn lines beginning at cursor line | CSI Pn M |
| Erase display: | |
| from cursor to end of screen | CSI 0 J |
| from beginning of screen to cursor | CSI 1 J |
| entire screen | CSI 2 J |
| Erase line: | |
| from cursor to end of line | CSI 0 K |
| from start of line to cursor | CSI 1 K |
| entire line | CSI 2 K |
| Erase Pn characters beginning at cursor column | CSI Pn X |

Character Sets

| | | |
|--|------------------|-------------------------------|
| Assign Ps character set as G0 | | Esc (Ps |
| Assign Ps character set as G1 | | Esc) Ps |
| Assign Ps character set as G2 | | Esc * Ps |
| Assign Ps character set as G3 | | Esc + Ps |
| Ps = B (ASCII) | Ps = R (French) | Ps = < (DEC multinational) |
| Ps = K (German) | Ps = Y (Italian) | Ps = 0 (DEC special graphics) |
| Ps = Z (Spanish) | Ps = = (Swiss) | Ps = %6 (Portuguese) |
| Map G0 to GL | | 0Fh |
| Map G1 to GL | | 0Eh |
| Map G2 to GL | | Esc n |
| Map G3 to GL | | Esc o |
| Map G1 to GR | | Esc ~ |
| Map G2 to GR | | Esc } |
| Map G3 to GR | | Esc |
| Temporarily map the G2 character set to GL, for the next character | | Esc N |
| Temporarily map the G3 character set to GL, for the next character | | Esc O |

Controlling Character Attributes

| | |
|--|----------------|
| Definition | CSI Ps;...Ps m |
| Ps = 0: normal | |
| Ps = 1: dim | |
| Ps = 4: underline (only monochrome VGA monitors) | |
| Ps = 5: blinking | |
| Ps = 7: reverse video | |
| Ps = 8: blank | |
| Ps = 22: normal | |
| Ps = 24: blinking off | |
| Ps = 25: underline off | |
| Ps = 27: reverse video off | |
| Ps = 3x: set foreground colour to colour x (x from 0 to 7) | |
| 0: black 1: red 2: green 3: brown | |
| 4: blue 5: magenta 6: cyan 7: white | |
| Ps = 4x: set background colour to colour x (x from 0 to 7) | |
| 0: black 1: red 2: green 3: brown | |
| 4: blue 5: magenta 6: cyan 7: white | |

Controlling the Terminal

| | |
|--|-----------------|
| Sound bell | 07h |
| Terminal mode on | CSI Ps;...Ps h |
| Ps = 2: lock keyboard | |
| Ps = 4: insert character mode | |
| Ps = 20: new line mode (LF=CR+LF) | |
| Ps = 54: ASCII mode | |
| Ps = ?1: cursor keys mode: application | |
| Ps = ?3: set 132-column display | |
| Ps = ?4: smooth scroll | |
| Ps = ?5: Light background (paper white) | |
| Ps = ?6: origin is scrolling region | |
| Ps = ?7: autowrap mode on | |
| Ps = ?8: autorepeat mode on | |
| Ps = ?12: turn the CAPS LED on | |
| Ps = ?18: print Form Feed (0Ch) mode on | |
| Ps = ?19: printer extent mode: screen | |
| Ps = ?25: enable cursor | |
| Ps = ?42: national mode | |
| Terminal mode off | CSI Ps;...Ps l* |
| Ps = 2: unlock keyboard | |
| Ps = 4: replace character mode | |
| Ps = 20: line feed mode | |
| Ps = 54: PC-scancode mode | |
| Ps = ?1: cursor keys mode: cursor | |
| Ps = ?2: entering VT52 Mode | |
| Ps = ?3: set 80-columns display | |
| Ps = ?4: jump scroll | |
| Ps = ?5: normal background | |
| Ps = ?6: origin is screen | |
| Ps = ?7: autowrap mode off | |
| Ps = ?8: autorepeat mode off | |
| Ps = ?12: turn the CAPS LED off | |
| Ps = ?18: print Form Feed (0Ch) mode off | |
| Ps = ?19: printer extent mode: region | |
| Ps = ?25: disable cursor | |
| Ps = ?42: multinational mode | |

* The last character in this sequence is a lowercase L

| | |
|---|-------------------------------|
| Define scrolling region (beginning line number, ending line number) | CSI Pn1;Pn2 r |
| Display 24 data lines + 1 message line | CSI < 0 I * |
| Display 25 data lines | CSI < 1 I |
| Enable main screen (24 lines) | CSI < 0 E |
| Enable message line (25 th . line) | CSI < 1 E |
| Keypad application mode | Esc = |
| Keypad numeric mode | Esc > |
| Double-width, double-height line (top half) | Esc # 3 |
| Double-width, double-height line (bottom half) | Esc # 4 |
| Single-width, single-height line | Esc # 5 |
| Double-width, single-height line | Esc # 6 |
| Enable view number Pn | CSI Pn z |
| Enable view number 1 | CSI U |
| Enable view number 2 | CSI V |
| Save current cursor position | Esc 7 |
| Restore cursor to saved position | Esc 8 |
| PC-scancode mode | CSI < 0 A |
| ASCII mode | CSI < 1 A |
| Disable colouring feature | CSI < 0 G |
| Enable colouring feature | CSI < 1 G |
| Set colours and enable colouring mode (4 pairs) | CSI < 2;Cn1;...;Cn8 G |
| Set a VGA palette colour | CSI < 3;Cn;Pn G |
| Change page (only if '4 views, 2 pages' is selected through the set-up) | CSI < Ps1;Ps2 L |
| Ps1 = 0: regular page changing | Ps2 = 0: enable next page |
| Ps1 = 1: copy current page to wanted page before swap | Ps2 = 1: enable page number 1 |
| Ps1 = 2: clear wanted page before swap | Ps2 = 2: enable page number 2 |
| Turn keyboard LEDs on or off | CSI < Pn1;Pn2;Pn3 O |
| Pn1 is the state of NUM LED, Pn2 is the state of CAPS LED and Pn3 is the state of SCROLL LED. | |
| The Pn parameter values should be: | |
| Pn = 0: the state of the LED is not modified | Pn = 1: turn the LED on |
| Pn = 1: turn the LED on | |
| Mouse feature (if set through the set-up) | CSI < Pn M ** |
| Pn = 0: disable mouse | Pn = 1: local mode |
| Pn = 2: raw mode | |
| Axel bitmap graphics functions | CSI < Ps;...Ps K *** |

* The last character in this sequence and in the next sequence is an uppercase i

** For more information, refer the concerned literature

*** For more information, refer the concerned literature

Printing Control Sequences

Select the default printer port: CSI < Po F
 TCP/IP models: Po = 1: AUX1 Po = 2: AUX2 Po = 3: parallel
 Serial models: Po = 1: AUX1 Po = 2: parallel

Using default port (serial or parallel): CSI Pn i
 Pn = 0: print screen Pn = 5: Enable local printing mode Pn = 4: Disable local printing mode

Enable Po auxiliary port for sending only (disable: CSI 4i) CSI < 5; Po C
 Enable receive mode of Po auxiliary port (only AUX1) CSI < 5; Po D
 Disable receive mode of Po auxiliary port (only AUX1) CSI < 4; Po D

TCP/IP models: Po = 0: default port Po = 1: AUX1 Po = 2: AUX2 Po = 3: parallel
 Serial models: Po = 0: default port Po = 1: AUX1 Po = 2: parallel

Print cursor line when 0Ah is received CSI ? 1 i
 Auto print mode on CSI ? 5 i
 Auto print mode off CSI ? 4 i

Protected Characters

Next written characters are protected CSI 1 " q
 Next written characters are unprotected CSI 2 " q (or CSI 0 " q)

Erase only unprotected characters in display:
 from cursor to end of screen CSI ? 0 J
 from beginning of screen to cursor CSI ? 1 J
 entire screen CSI ? 2 J

Erase only unprotected characters in line:
 from cursor to end of line CSI ? 0 K
 from start of line to cursor CSI ? 1 K
 entire line CSI ? 2 K

Programming Function Keys

VT220 mode: Esc P Ps1 ; Ps2 | Keyn / Stn { ; Keyn / Stn } Esc \

Ps1=0: clear all keys before loading new values (default value)

Ps1=1: clear one key at a time, before loading a new value

Ps2=0: lock the keys (default value)

Ps2=1: do not lock the keys

Keyn: the key selector number indicates which key you are defining

| | | |
|------------------|----------------------|-----------------------|
| 17: <Shift><F6> | 23: <Shift><F11> | 29: <Alt><Shift><F8> |
| 18: <Shift><F7> | 24: <Shift><F12> | 31: <Alt><Shift><F9> |
| 19: <Shift><F8> | 25: <Alt><Shift><F5> | 32: <Alt><Shift><F10> |
| 20: <Shift><F9> | 26: <Alt><Shift><F6> | 33: <Alt><Shift><F11> |
| 21: <Shift><F10> | 28: <Alt><Shift><F7> | 34: <Alt><Shift><F12> |

Stn: the string parameter is the key definition, encoded as pairs of hexadecimal codes.

Example: LOG <RC> is coded by 4C4F470D

AXEL mode: CSI < Code P Terminator Message Terminator

- Code: function key (refer to appendix A.3 or see the AX3000 set-up)
- Terminator: one character (>20h)
- Message: key definition (any character except Terminator). Character '^' (5Eh) indicates 20h must be subtracted from the next character.

Example: **CSI < 1 P amenu^a, <F1>** sends **menu <RC>**

Resetting the Terminal

Hard terminal reset

Esc c

Soft terminal reset

CSI 0 ! p

Select an operating level

CSI Ps1;Ps2 " p

Ps1 = 61: level 1 (VT100)

Ps2 = 0: 8-bit controls (level 2 only)

Ps1 = 62: level 2 (VT220)

Ps2 = 1: 7-bit controls

Ps2 = 2: 8-bit controls (level 2 only)

Reports

| | | |
|---|------------------------|-------------|
| AX3000 IP address | CSI < a (or CSI < 0 a) | |
| Response: IP address <CR> | | |
| Firmware revision | CSI < 1 a | |
| Response: version <CR> | | |
| Answerback message (set through the AX3000 Set-Up) | CSI < 4 a | |
| Response: message | | |
| Current session number | CSI < 5 a | |
| Response: number <CR> | | |
| Printer Status | CSI < 6 a | |
| Response: OK <CR> or ERR <CR> | | |
| Primary Device Attributes request | CSI c (or Esc Z) | |
| Response: CSI ? 62 ; 1 ; 2 ; 6 ; 7 ; 8 ; 9 c | | |
| Secondary Device Attributes request | CSI > c | |
| Response: CSI > 1 ; 10 ; 0 c | | |
| AX3000 operating status | CSI 5 n | |
| Response: CSI 0 n (ready) | | |
| Cursor position report | CSI 6 n | |
| Response: CSI Pn1; Pn2 R (Pn1 = line number, Pn2 = column number) | | |
| Printer status | CSI ? 15 n | |
| Response: CSI ? 10 n (printer ready) | | |
| CSI ? 11 n (printer not ready) | | |
| UDK (Programming function keys) report | CSI ? 25 n | |
| Response: CSI ? 20 n (UDKs unlocked) | | |
| CSI ? 21 n (UDKs locked) | | |
| Keyboard language | CSI ? 26 n | |
| Response: CSI ? 27;Ps n | | |
| Ps values: 1: North American | 7: German | 9: Italian |
| 10: Swiss | 14: French | 15: Spanish |
| 16: Portuguese | | |

TCP/IP Status Line (set the associated label)

Syntax is: CSI < c Terminator Message Terminator

- Terminator: one character (>20h)
- Message: session label.

Example: **CSI <czview 1z**

2.3 - WYSE 60 EMULATION

Cursor Commands

| | |
|---|------------------------------|
| Cursor left | 08h |
| Cursor right | 0Ch |
| Cursor up; no scroll | 0Bh |
| Cursor up; scroll | Esc j |
| Cursor down; scroll | 0Ah |
| Cursor to start of next line | 1Fh |
| cursor to start of line | 0Dh |
| Home cursor | Esc { or 1Eh |
| Address cursor in current 80-column page | Esc = <i>line col</i> |
| Address cursor in current 80/132-column page | Esc a <i>l/l R ccc C</i> |
| Address cursor in a specific 80-column page | Esc w @ <i>page line col</i> |
| Address cursor in a specific 80-column page or window | Esc - <i>page line col</i> |

Editing

| | |
|-------------------------|----------------|
| Set tab stop | Esc 1 |
| Clear tab stop | Esc 2 |
| Clear all tab stops | Esc 0 or Esc 3 |
| Tabulate cursor | Esc i or 09h |
| Backtab | Esc I * |
| Insert space character | Esc Q |
| Insert line of spaces | Esc E |
| Insert column of nulls | Esc c M |
| Delete cursor character | Esc W |
| Delete cursor line | Esc R |
| Delete cursor column | Esc c J |
| Clear page to nulls | Esc * |
| Clear page to spaces | Esc + |

Character sets

Load *set* in *bank* Esc c @ *bank set*

bank is a buffer (0 to 3)

Values of *set*:

| | | | |
|------------------|-----------------------|---------------------|-----------------|
| '@': native mode | 'A': PC multinational | 'B': standard ASCII | 'C': graphics 1 |
| 'D': PC standard | 'E': graphics 2 | 'F': graphics 3 | |

* The last character in this sequence is an uppercase i

| | |
|---|---------------------|
| Define primary character set (<i>code</i> is a <i>bank</i> or a <i>set</i>) | Esc c B <i>code</i> |
| Define secondary character set (<i>code</i> is a <i>bank</i> or a <i>set</i>) | Esc c C <i>code</i> |
| Select primary character set | Esc c D |
| Select secondary character set | Esc c E |

Video Attributes

| | |
|------------------------------------|-------------------|
| Assign character display attribute | Esc G <i>attr</i> |
|------------------------------------|-------------------|

attr values:

| | |
|---|--|
| 0 : normal | p : dim |
| 1 : invisible | q : invisible + dim |
| 2 : blink | r : blink + dim |
| 3 : invisible + blink | s : invisible + dim |
| 4 : reverse | t : reverse + dim |
| 5 : reverse + invisible | u : invisible + reverse + dim |
| 6 : reverse + blink | v : reverse + blink + dim |
| 7 : reverse + blink + invisible | w : reverse + blink + invisible + dim |
| 8 : underscore | x : underscore + dim |
| 9 : underscore + invisible | y : underscore + invisible + dim |
| : : underscore + blink | z : underscore + blink + dim |
| ; : underscore + blink + invisible | { : underscore + blink + invisible + dim |
| < : underscore + reverse | : underscore + reverse + dim |
| = : underscore + reverse + invisible | } : underscore + reverse + invisible + dim |
| > : underscore + reverse + blink | ~ : underscore + reverse + blink + dim |
| ? : underscore + reverse + invis. + blink | 7Fh : underscore + reverse + invisible + blink + dim |

| | |
|--|---------------------|
| Character attribute mode off | Esc e 0 |
| Character attribute mode on | Esc e 1 |
| Page attribute mode on | Esc e 2 |
| Line attribute mode on | Esc e 3 |
| Assign display attribute to message field | Esc A 1 <i>attr</i> |
| Assign display attribute to screen | Esc A 0 <i>attr</i> |
| single-high, single-wide characters | Esc G @ |
| single-high, double-wide characters | Esc G A |
| Top half of double-high, single-wide characters | Esc G B |
| Bottom half of double-high, single-wide characters | Esc G C |
| Top half of double-high, double-wide characters | Esc G D |
| Bottom half of double-high, double-wide characters | Esc G E |

Controlling the terminal

| | |
|---|-----------------------------|
| Sound bell | 07h |
| Lock keyboard | 0Fh or Esc # |
| Unlock keyboard | 0Eh or Esc " |
| Monitor mode on | Esc U |
| Monitor mode off | Esc u or Esc X |
| ACK mode on | Esc e 7 |
| ACK mode off | Esc e 6 |
| Set MAIN port operating parameters (serial model only) | Esc c 0 bds stp parity word |
| → after this command, an ACK is sent by the terminal (06h) if ACK mode is on | |
| <i>bds</i> values: 0=38400, 1=19200, 2=9600, 3=4800, 4=2400, 7=1200 and 9=300 | |
| <i>stp</i> values: 0=1 bit | |
| <i>parity</i> values: 0=none, 1=odd and 3=even | |
| <i>word</i> values: 0=7 bits and 1= 8 bits | |
| Set AUX1 port operating parameters (serial model only) | Esc c 1 bds stp parity word |
| → after this command, an ACK is sent by the terminal (06h) if ACK mode is on | |
| <i>bds</i> values: 0=19200, 1=9600, 3=4800, 5=2400, 8=1200 and :=300 | |
| <i>stp</i> values: 0=1 bit | |
| <i>parity</i> values: 0=none, 1=odd and 3=even | |
| <i>word</i> values: 0=7 bits and 1= 8 bits | |
| Set MAIN port handshaking (serial model only) | Esc c 2 <i>hdsk</i> |
| → after this command, an ACK is sent by the terminal (06h) if ACK mode is on | |
| <i>hdsk</i> values: 0=none, 1= xon/xoff and 2=DTR | |
| Set AUX1 port handshaking (serial model only) | Esc c 5 <i>hdsk</i> |
| → after this command, an ACK is sent by the terminal (06h) if ACK mode is on | |
| <i>hdsk</i> values: 0=none, 1= xon/xoff and 2=DTR | |
| Local edit mode on (duplex off) | Esc k |
| Duplex edit mode on (local off) | Esc l* |
| Key repeat off | Esc e, |
| Key repeat on | Esc e- |
| autoscrolling mode off | Esc N |
| autoscrolling mode on | Esc O |
| End-of-line wrap mode off | Esc d. |
| End-of-line wrap mode on | Esc d/ |
| Receive CR mode off | Esc e 4 |
| Receive CR mode on | Esc e 5 |
| Insert mode on (replace mode off) | Esc q |

* The last character in this sequence is a lowercase L

| | |
|--|--|
| Replace mode on (insert mode off) | Esc r |
| Page edit mode off | Esc e " |
| Page edit mode on | Esc e # |
| CAPS LOCK on | Esc e & |
| CAPS LOCK off | Esc e ' |
| ASCII mode | Esc e H |
| PC-scancode mode | Esc e I * |
| Turn screen display off | Esc ` 8 |
| Turn screen display on | Esc ` 9 |
| Screen saver on | Esc e Q |
| Screen saver off | Esc e P |
| Set scrolling type | Esc ` scroll |
| scroll = '@': jump scroll | scroll = '<', '=', '>' or '?': smooth scroll |
| Cursor off | Esc ` 0 |
| Cursor on | Esc ` 1 |
| Set cursor type | Esc ` curs |
| curs = '2' or '5': blinking block | curs = '3' or '4': blinking line |
| Line lock mode on | Esc ` H |
| Line lock mode off | Esc ` I ** |
| Select 80-column display | Esc ` : |
| Select 132-column display | Esc ` ; |
| Display 24 data lines | Esc e (|
| Display 25 data lines | Esc e) |
| Display previous page | Esc w B |
| Display next page | Esc w C |
| Display specific page (<i>num</i> =0 or <i>num</i> =1) | Esc w <i>num</i> |
| Display specific session (<i>num</i> 0 to 8). Serial model only | Esc [<i>num</i> z |
| Graphics mode on | Esc H 02h |
| Graphics mode off | Esc H 03h |
| Display graphics character <i>char</i> | Esc H <i>char</i> |
| Box rectangle in 80-column page | Esc c G <i>line col</i> |
| Clear entire rectangle in 80-column page | Esc c H <i>line col char</i> |

* The last character in this sequence is an uppercase i

** The last character in this sequence is an uppercase i

Message Line

| | |
|--|------------------------------|
| Program and display unshifted label line | Esc z (<i>txt</i> 0Dh |
| Program shifted label line | Esc z) <i>txt</i> 0Dh |
| Shifted label line off | Esc z 7Fh |
| Clear unshifted label line message | Esc z (0Dh |
| Clear shifted label line message | Esc z) 0Dh |
| Clear function key label | Esc z <i>field</i> 0Dh |
| Program and display function key label | Esc z <i>field label</i> 0Dh |
| <i>field</i> values: <F1> to <F12>: 30h to 3Bh <Shift><F1> to <Shift><F12>: 50h to 5Bh | |

Protected Data

| | |
|---|---------------------------------|
| Protect mode on | Esc & |
| Protect mode off | Esc ' |
| Write-protect mode off | Esc (|
| Write-protect mode on | Esc) |
| Clear page to write-protected spaces | Esc , |
| Clear cursor column from cursor | Esc V |
| Clear unprotected ...: | |
| page to spaces | Esc ; or 1Ah |
| page to nulls | Esc : |
| page to specific character | Esc . <i>char</i> |
| line to spaces from cursor | Esc T |
| line to nulls from cursor | Esc t |
| page to spaces from cursor | Esc Y |
| page to nulls from cursor | Esc y |
| to end of line with nulls | Esc c L |
| column to specific character | Esc c <i>char</i> * |
| Clear unprotected rectangle in 80-column page | Esc c F <i>high length char</i> |

* The character after 'c' in this sequence is an uppercase i

Sending Data

| | |
|--|----------------|
| Print formatted page | Esc P |
| → after this command, an ACK is sent by the terminal (06h) if ACK mode is on | |
| Print formatted unprotected page | Esc @ |
| → after this command, an ACK is sent by the terminal (06h) if ACK mode is on | |
| Print unformatted page | Esc p or Esc L |
| → after this command, an ACK is sent by the terminal (06h) if ACK mode is on | |
| Transparent print mode on | Esc d # or 18h |
| Auxiliary print mode on | 12h |
| Turn print modes off (transparent mode and auxiliary print mode) | 14h |
| Secondary receive mode off | Esc d 20h |
| Secondary receive mode on | Esc d ! |
| Bidirectional mode off | Esc d \$ |
| Bidirectional mode on | Esc d % |

Programmable keys

WYSE Mode:

Program:

1) Syntax: Esc z key sequence 7Fh

Key: key number

Function keys:

<F1> to <F12>: 40h to 4Bh

<Shift><F1> to <Shift><F12>: 60h to 6Bh

Arrows keypad:

up: 2Bh down: 2Ch left: 2Dh right: 2Eh

Editing keypad:

Insert: 70h Home: 2Ah PageUp: 77h

Delete: 23h End: 5Ch PageDn: 72h

Other keys:

Esc: 20h Backspace: 22h

Sequence: up to 32 bytes to be loaded in the key.

2) Syntax: Esc Z dir key sequence 7Fh

dir: <0> = normal <1> = remote <2> = local

key et sequence: see above

Clear:

Esc z key 7Fh or Esc Z dir key 7Fh

AXEL Mode:

Syntax is: CSI < Code P Terminator Message Terminator

- Code: function key (refer to appendix A.3 or see the AX3000 set-up)
- Terminator: one character (>20h)
- Message: key definition (any character except Terminator). Character '^' (5Eh)

indicates 20h must be subtracted from the next character.

Example: **CSI < 1 P amenu^a, <F1> sends menu <RC>**

Terminal Report

| | |
|---|------------------------|
| AX3000 IP address | CSI < a (or CSI < 0 a) |
| Response: IP address <CR> | |
| Firmware revision | CSI < 1 a |
| Response: version <CR> | |
| Answerback message (set through the AX3000 Set-Up) | CSI < 4 a |
| Response: message | |
| Current session number | CSI < 5 a |
| Response: number <CR> | |
| Printer Status | CSI < 6 a |
| Response: OK <CR> or ERR <CR> | |
| Terminal identification | Esc 20h |
| Terminal returns: 6 0 <RC> | |
| Read Programmable key value | Esc Z ~ key |
| Terminal returns: dir key sequence 7Fh | |
| Read cursor address in current 80-column page | Esc ? |
| Terminal returns: line col <RC> | |
| Read 80-column page number and cursor address | Esc w ` |
| Terminal returns: num line col <RC> | |
| Read 80-column page (or window) number and cursor address | Esc / |
| Terminal returns: num line col <RC> | |
| Read cursor address in current 80/132-column page | Esc b |
| Terminal returns: line R col C | |
| Send ACK | 05h |
| Terminal returns (if ACK mode is on): 06h | |

2.4 - PCTERM FAMILY

This family is composed by the PCTERM, PCTERM THEOS and OS2 POLYMOD2 emulation.

Note: in following terminal commands, italic and underscored parameter values are from 00h to FFh. Other parameter values are greater than 20h.

Controlling Cursor

| | |
|---|---------------------------------------|
| Cursor left | 08h |
| Cursor right | 0Ch |
| Cursor up (no scroll) | 0Bh |
| Cursor up ; scroll | Esc j |
| Cursor down (no scroll) | 16h |
| Cursor down ; scroll | 0Ah |
| Cursor to line 1 and column 1 | 1Eh |
| Cursor to start of line | 0Dh |
| Cursor to start of next line | 1Fh |
| Cursor to line Pn1 (0..24) and column Pn2 (0..79) | Esc = <u>Pn1</u> +20h <u>Pn2</u> +20h |

Editing

| | |
|--|------------------|
| Move cursor to next tab stop | 09h |
| Move cursor to previous tab stop | Esc I* |
| Set tab stop at cursor position | Esc 1 |
| Clear tab stop at cursor position | Esc 2 |
| Clear all tab stops | Esc 3 |
| Insert a space character at cursor position | Esc Q |
| Insert a line of space characters at cursor line | Esc E |
| Delete cursor character | Esc W |
| Delete cursor line | Esc R |
| Clear screen to nulls | Esc * |
| Clear screen to spaces | Esc + |
| Clear screen to write-protected spaces | Esc , |
| Clear screen to character <u>car</u> | Esc F <u>car</u> |

* The last character in this sequence is an uppercase i

Controlling the Terminal

| | | | |
|---|----------------------|--|--------------------------------------|
| Sound a bell | | | 07h |
| Lock keyboard | | | Esc # |
| Unlock keyboard | | | Esc " |
| Set cursor style | | | Esc . Pn1 |
| Pn1 = 0 (invisible) | Pn1 = 1 (visible) | | Pn1= 2 (block) |
| Pn1 = 3 (underline) | Pn1 = 4 (underline) | | Pn1= 5 (block) |
| Autowrap mode on | | | Esc ~ |
| Autowrap mode off | | | Esc 0 |
| Insert mode on (replace mode off) | | | Esc Z |
| Replace mode on (insert mode off) | | | Esc r |
| Monitor mode on | | | Esc U |
| Monitor mode off | | | Esc u (or Esc X) |
| Restore normal screen | | | Esc d |
| Reverse screen | | | Esc b |
| Turn screen display off | | | Esc O (or Esc 20h 8) |
| Turn screen display on | | | Esc N (or Esc 20h 9) |
| ASCII mode | | | Esc c (or Esc 20h q or Esc 20h r) |
| PC-Scancode mode | | | Esc H (or Esc 20h p) |
| Set hardware handshake (DTR) | | | 0Eh |
| Set software handshake (XON/XOFF or XPC) | | | 0Fh |
| Set 80-column display | | | Esc m |
| Set 132-column display | | | Esc n |
| Display 25 data lines (clear screen) | | | Esc ^ |
| Display 25 data lines (no clear screen) | | | Esc e (or Esc h) |
| Display 24 data lines + 1 status line (no clear screen) | | | Esc g |
| Display computer message in status line | | | Esc f str 0Dh |
| 'new line' mode on (CR=CR+LF) | | | Esc 8 |
| 'new line' mode off | | | Esc 9 |
| Full duplex mode on | | | Esc } |
| Autoscrolling mode on | | | Esc 20h v (or Esc 20h @) |
| Autoscrolling mode off | | | Esc w |
| Set-up MAIN port (serial model only) | | | Esc 20h t p1 p2 p3 |
| p1 = 0 (8-bit control) | p2 = 0 (no parity) | | p3 = 0 (1 stop bit) |
| p1 = 1 (7-bit control) | p2 = 1 (even parity) | | p3 = 1 (2 stop bit) |
| | p2 = 2 (odd parity) | | |
| NUM LED on | | | Esc 20h J |
| NUM LED off | | | Esc 20h K |

| | |
|---------------|-----------|
| MAJ LED on | Esc 20h L |
| MAJ LED off | Esc 20h M |
| DEFIL LED on | Esc 20h N |
| DEFIL LED off | Esc 20h O |

Printing Control Sequences

| | |
|--------------------------------|-------------|
| Print screen | Esc P |
| Transparent print mode on | Esc ` |
| Transparent print mode off | Esc a |
| Non-transparent print mode on | Esc @ (12h) |
| Non-transparent print mode off | Esc A (14h) |
| Print next character | 10h |

Controlling Character Attributes (except OS/2 POLYMOD2)

| | | | |
|-------------|-------------------------|--------------------------------------|------------|
| Definition | | | Esc G attr |
| attr values | 0 : Normal | p or @ : Normal + Dim | |
| | 1 : Invisible | q or A : Invisible + Dim | |
| | 2 : Blink | r or B : Blink + Dim | |
| | 3 : Invisible | s or C : Invisible + Dim | |
| | 4 : Reverse | t or D : Reverse + Dim | |
| | 5 : Invisible + Reverse | u or E : Invisible + Reverse + Dim | |
| | 6 : Reverse + Blink | v or F : Reverse + Blink + Dim | |
| | 7 : Invisible + Reverse | w or G : Invisible + Reverse + Dim | |
| | 8 : Underline | x or H : Underline + Dim | |
| | 9 : Invisible | y or I : Invisible + Dim | |
| | : : Underline + Blink | z or J : Underline + Blink + Dim | |
| | ; : Invisible | { or K : Invisible + Dim | |
| | < : Underline | or L : Underline + Dim | |
| | = : Invisible + Reverse | } or M : Invisible + Reverse + Dim | |
| | > : Underline + Blink | ~ or N : Underline + Blink + Dim | |
| | ? : Invisible + Reverse | 7Fh or o : Invisible + Reverse + Dim | |

Colour Character Attributes (only for THEOS)

| | | | | |
|--------------------------|------------------------------|-------------------------------|-----------|----------|
| Definition | Esc / c1 c2 c3 c4 | | | |
| | c1: foreground normal colour | c3: foreground reverse colour | | |
| | c2: background normal colour | c4: background reverse colour | | |
| c1, c2, c3 et c4 values: | | | | |
| | 0: black | 1: blue | 2: green | 3: cyan |
| | 4: red | 5: magenta | 6: yellow | 7: white |

Character Attributes (only for OS/2 POLYMOD2)

Definition Esc G attr
 The format of attr is the format of the standard VGA character attribute

Write-Protected Characters (only THEOS)

A write-protected character is written with the dim attribute (cf. character attributes)

| | |
|--|--------------|
| Protect mode on | Esc & |
| Protect mode off | Esc ' |
| Characters are written only in the protected regions | Esc (|
| Characters are written everywhere | Esc) |
| Clear unprotected: | |
| screen to spaces | Esc ; or 1Ah |
| screen to nulls | Esc : |
| line to spaces from cursor | Esc T |
| line to nulls from cursor | Esc t |
| screen to spaces from cursor | Esc Y |
| screen to nulls from cursor | Esc y |

Programming Function Keys

Syntax is: Esc z Keyn message 7Fh

| | | | |
|------|----------------|-----|----------------|
| Keyn | : key selector | | |
| @ | : <F1> | ` | : <Shift><F1> |
| A | : <F2> | a | : <Shift><F2> |
| ... | ... | ... | ... |
| K | : <F12> | k | : <Shift><F12> |

message : definition string (length max. 32, any character except 7Fh).

2.5 - SM94XX FAMILY

This family is composed by the SM9400 and SM9412 emulations.

These emulations are dedicated to a legacy operating system especially used in France. So, the description of terminal commands are only given in the French manual.

2.6 - PROLOGUE FAMILY

This family is composed by the PROLOGUE 2/3, PROLOGUE 4/5 and TWIN SERVER emulations.

These emulations are dedicated to a legacy operating system especially used in France. So, the description of terminal commands are only given in the French manual.

2.7 - QVT119+ EMULATION

Cursor Commands

| | |
|--|--|
| Cursor left | 08h |
| Cursor right | 0Ch |
| Cursor up; no scroll | 0Bh |
| Cursor up; scroll | Esc J |
| Cursor down; scroll | 0Ah |
| Cursor to start of next line | 1Fh |
| cursor to start of line | 0Dh |
| Home cursor | 1Eh |
| Address cursor in current 80-column page | Esc = <i>line col</i> |
| Address cursor in current 80-column or 132-column page | Esc = <i>line n col</i> |
| Address cursor in a specific 80-column page | Esc - <i>page line col</i> |
| Address cursor line (current line not modified) | Esc : <i>line</i> or Esc [<i>line</i> |
| Address cursor column (current column not modified) | Esc] <i>line</i> |
| Address cursor in current 80/132-column page | Esc ^ <i>lll R ccc C</i> |

Editing

| | |
|-------------------------|-----------------|
| Set tab stop | Esc 1 |
| Clear tab stop | Esc 2 |
| Clear all tab stops | Esc 3 |
| Tabulate cursor | 09h |
| Backtab | Esc I * |
| Insert space character | Esc Q |
| Insert line of spaces | Esc E |
| Delete cursor character | Esc W |
| Delete cursor line | Esc R |
| Clear page to nulls | Esc *0 |
| Clear page to spaces | Esc *1 or Esc + |
| Clear screen | 1Ah |

* The last character in this sequence is an uppercase i

Video Attributes

Assign character display attribute Esc G attr

attr values for full-intensity:

| | | | |
|---|-------------------------------|---|--|
| 0 | : normal | 8 | : underscore |
| 1 | : invisible | 9 | : underscore + invisible |
| 2 | : blink | : | : underscore + blink |
| 3 | : invisible + blink | ; | : underscore + blink + invisible |
| 4 | : reverse | < | : underscore + reverse |
| 5 | : reverse + invisible | = | : underscore + reverse + invisible |
| 6 | : reverse + blink | > | : underscore + reverse + blink |
| 7 | : reverse + blink + invisible | ? | : underscore + reverse + invisible + blink |

attr values for half-intensity:

| | | | |
|-----|-------------------------------|---|--|
| 20h | : normal | (| : underscore |
| ! | : invisible |) | : underscore + invisible |
| " | : blink | * | : underscore + blink |
| # | : invisible + blink | + | : underscore + blink + invisible |
| \$ | : reverse | , | : underscore + reverse |
| % | : reverse + invisible | - | : underscore + reverse + invisible |
| & | : reverse + blink | . | : underscore + reverse + blink |
| ' | : reverse + blink + invisible | / | : underscore + reverse + invisible + blink |

Message Line

| | |
|---|---------------------|
| Program and display label line | Esc f txt 0Dh |
| Display label line | Esc g |
| Clear label line | Esc h |
| Set message line video attribute (<i>attr</i> : see above) | Esc a 1 <i>attr</i> |

Protected Data

| | |
|----------------------------|--------|
| Protect mode on | Esc & |
| Protect mode off | Esc ' |
| Write-protect mode off | Esc (|
| Write-protect mode on | Esc) |
| Clear unprotected ...: | |
| line to spaces from cursor | Esc T |
| line to nulls from cursor | Esc t |
| page to spaces from cursor | Esc Y |
| page to nulls from cursor | Esc y |
| page to spaces | Esc *3 |
| page to nulls | Esc *2 |

Controlling the terminal

| | |
|-----------------------------------|----------------------------------|
| Sound bell | 07h |
| Lock keyboard | Esc # |
| Unlock keyboard | Esc " |
| Monitor mode on | Esc U |
| Monitor mode off | Esc u or Esc X |
| Graphics mode on | Esc \$ |
| Graphics mode off | Esc % |
| Insert mode on (replace mode off) | Esc q |
| Replace mode on (insert mode off) | Esc r |
| Cursor on/off | Esc . 0 |
| Set cursor type | Esc ` curs |
| curs = '1' or '2': blinking block | curs = '3' or '4': blinking line |
| Normal screen on | Esc n 0 or Esc a 0 0 |
| Reverse screen on | Esc n 1 or Esc a 0 4 |
| Turn screen display off | Esc n 2 |
| Turn screen display on | Esc n 3 |
| Select 80-column display | Esc n 4 |
| Select 132-column display | Esc n 5 |
| End-of-line wrap mode on | Esc n A |
| End-of-line wrap mode off | Esc n @ |
| Set 'jump scrolling' mode | Esc n 8 or Esc j |
| Set 'smooth scrolling' mode | Esc n x (x is 9 : ; < = > ?) |
| | or Esc s |
| autoscrolling mode on/off | Esc H |
| Display next page | Esc w + |
| Display previous page | Esc w - |
| Display specific page | Esc w num P |
| Sending Data | |
| Transparent print mode on | 12h or Esc ` |
| Transparent print mode off | 14h |
| COPY mode on | Esc @ |
| COPY mode off | Esc A |
| Print page | Esc P |
| Print page to cursor | Esc N |

Programmable keys

Program: Esc z route key del sequence del

route: non-significant

Key: key number

Function keys:

<F1> to <F12>: 40h to 4Bh

<Shift><F1> to <Shift><F12>: 60h to 6Bh

Arrows keypad:

up: 20h down: 21h left: 22h right: 23h

del: one character (>20h)

Sequence: key definition (any character except Del)

Set default value for a key : Esc K route key del del

route, key and del: see above

Set default value for all keys: Esc K Z

Terminal Report

Answerback message (set through the AX3000 Set-Up)

05h

Response: message

ACK (if answerback message is not defined)

05h

Response: 06h

Read cursor address in current 80-column page

Esc ?

Terminal returns: line col <RC>

Read 80-column page number and cursor address

Esc / or Esc ~

Terminal returns: num line col <RC>

2.8 - TVI EMULATION

Cursor Commands

| | |
|---|----------------------------|
| Cursor left | 08h |
| Cursor right | 0Ch |
| Cursor up; no scroll | 0Bh |
| Cursor up; scroll | Esc j |
| Cursor down; scroll | 0Ah |
| Cursor down; no scroll | 16h |
| Cursor to start of next line | 1Fh |
| cursor to start of line | 0Dh |
| Home cursor | 1Eh |
| Address cursor in current 80-column page | Esc = <i>line col</i> |
| Address cursor in a specific 80-column page or window | Esc - <i>page line col</i> |

Editing

| | |
|-----------------------|--------------|
| Set tab stop | Esc 1 |
| Clear tab stop | Esc 2 |
| Clear all tab stops | Esc 3 |
| Tabulate cursor | Esc i or 09h |
| Backtab | Esc I * |
| Insert line of spaces | Esc E |
| Delete cursor line | Esc R |
| Clear page to nulls | Esc * |
| Clear page to spaces | Esc + |

Controlling the terminal

| | |
|------------------------------------|----------------|
| Sound bell | 07h |
| Lock keyboard | Esc # |
| Unlock keyboard | Esc " |
| Monitor mode on | Esc U |
| Monitor mode off | Esc u or Esc X |
| Graphics mode on | Esc \$ |
| Graphics mode off | Esc % |
| Character mode on (block mode off) | Esc C |
| Full-duplex mode on | Esc DF |
| Half-duplex mode on | Esc DH |

* The last character in this sequence is an uppercase i

Protected Data

| | |
|---------------------------------|-----------------------|
| Protect mode on | Esc & |
| Protect mode off | Esc ' |
| Write-protect mode off | Esc (|
| Write-protect mode on | Esc) |
| Clear cursor column from cursor | Esc V |
| Clear unprotected ...: | |
| page to spaces | Esc ; or 1Ah or Esc , |
| page to nulls | Esc : |
| line to spaces from cursor | Esc T |
| line to nulls from cursor | Esc t |
| page to spaces from cursor | Esc Y |
| page to nulls from cursor | Esc y |

Sending Data

| | |
|----------------------------|-------|
| Print formatted page | Esc P |
| Print unformatted page | L |
| Transparent print mode on | Esc ' |
| Transparent print mode off | Esc a |
| Secondary receive mode off | 12h |
| Secondary receive mode on | 14h |
| COPY mode on | Esc @ |
| COPY mode off | Esc A |

Programmable keys

| | |
|-------------------------------|-------------------------------|
| Program (from WYSE emulation) | Esc z <i>key sequence</i> 7Fh |
|-------------------------------|-------------------------------|

Terminal Report

| | |
|---|-------|
| Answerback message (set through the AX3000 Set-Up) | Esc M |
| Response: message (or 60 <CR> if message is null) | |
| Read cursor address in current 80-column page | Esc ? |
| Terminal returns: line col <RC> | |
| Read 80-column page (or window) number and cursor address | Esc / |
| Terminal returns: num line col <RC> | |
| Send ACK | 05h |
| Terminal returns: 06h | |

2.9 - 3151 EMULATION

Cursor Commands

| | |
|--|-------------------|
| Cursor right | Esc C |
| Cursor left | Esc D |
| Cursor up (no scroll) | Esc A |
| Cursor up (scroll) | Esc ! M |
| Cursor down (no scroll) | Esc B |
| Cursor down (scroll) | Esc 20 M |
| Cursor to start of next line | Esc M |
| Cursor to next line (same column) | 0Ah |
| Cursor to start of line | 0Dh |
| Home cursor | Esc H |
| Set cursor address: line Pn1 (20h...38h), column Pn2 (20h...6Fh) | Esc Y Pn1 Pn2 |
| Set cursor address: line Pn1 (1..25), column Pn2 (1..80) | Esc [Pn1 ; Pn2 H |
| Set buffer address line Pn1 (20h...38h), column Pn2 (20h..6Fh) | Esc X Pn1 Pn2 |
| Reset buffer address mode | Esc 20h Z |
| Insert cursor | Esc Z |

Editing

| | |
|------------------------------|---------------------------|
| Set tab stop | Esc 0 |
| Tabulate cursor | 09h |
| Backtab | Esc 2 |
| Clear tab stop | Esc 1 |
| Clear all tab stops | Esc 20h 1 |
| Clear screen and home cursor | Esc L or Esc K or Esc ! L |
| Clear screen from cursor | Esc J |
| Clear line from cursor | Esc I |
| Insert a line | Esc N |
| Delete cursor line | Esc O |
| Insert character Pn | Esc P Pn |
| Delete cursor character | Esc Q |

Terminal Commands

| | |
|---|----------------------|
| Reset to initial state | Esc 20h S |
| Sound bell | 07h |
| Lock keyboard | Esc : |
| Unlock keyboard | Esc ; |
| Assign Pn character set as G0 | Esc < Pn |
| Assign Pn character set as G1 | Esc > Pn |
| Set a 24x80 screen | Esc 20h r!! 20h 8"P |
| Set a 25x80 screen | Esc 20h r!! 20h 9"P |
| Set a 24x132 screen | Esc 20h r!! 20h 8\$D |
| Set a 25x132 screen | Esc 20h r!! 20h 9\$D |
| Enable 'Impr' key (hardcopy sequence is sent when the key is pressed) | Esc) : |
| Disable 'Impr' key (the hardcopy is locally performed) | Esc) ; |

Programmable Keys

| | |
|-----------------------------------|-----------|
| Set all default programmable keys | Esc 20h t |
|-----------------------------------|-----------|

Printing Control Sequences

| | |
|---|--------------------|
| Enable local printing mode | 10h 14h |
| Disable local printing mode | 10h 12h |
| Print the screen (hardcopy) | Esc W or Esc 20h W |
| Select the default printer port: | CSI < Po F |
| TCP/IP models: Po = 1: AUX1 Po = 2: AUX2 Po = 3: parallel | |
| Serial models: Po = 1: AUX1 Po = 2: parallel | |

Video Attributes

| | |
|--|---------------------|
| Assign character display attribute (additive sequence) | Esc 4 <i>attr</i> a |
|--|---------------------|

attr values:

| | | |
|----|---|-------------------------------------|
| | (| : bold |
| ! | : | reverse |
|) | : | bold + reverse |
| " | : | underscore |
| * | : | bold + underscore |
| # | : | underscore + reverse |
| + | : | bold + underscore + reverse |
| \$ | : | blink |
| , | : | bold + blink |
| % | : | reverse + blink |
| - | : | bold + reverse + blink |
| & | : | underscore + blink |
| . | : | bold + underscore + blink |
| ' | : | reverse + underscore + blink |
| / | : | bold + reverse + underscore + blink |
| 0 | : | invisible |

| | |
|--|-------------------|
| Assign character display attribute (non-additive sequence) | Esc 4 <i>attr</i> |
|--|-------------------|

attr values:

| | |
|----------------------------------|---|
| @ : normal (no attribute) | H : bold |
| A : reverse | I : bold + reverse |
| B : underscore | J : bold + underscore |
| C : underscore + reverse | K : bold + underscore + reverse |
| D : blink | L : bold + blink |
| E : reverse + blink | M : bold + reverse + blink |
| F : underscore + blink | N : bold + underscore + blink |
| G : reverse + underscore + blink | O : bold + reverse + underscore + blink |
| P : invisible | |

Reset character display attribute

Esc 4 *attr* b

attr values:

| | |
|---|----------------------------------|
| 0 : bold + reverse + underscore + blink | 8 : reverse + underscore + blink |
| 1 : bold + underscore + blink | 9 : underscore + blink |
| 2 : bold + reverse + blink | : : reverse + blink |
| 3 : bold + blink | ; : blink |
| 4 : bold + underscore + reverse | < : underscore + reverse |
| 5 : bold + underscore | = : underscore |
| 6 : bold + reverse | > : reverse |
| 7 : bold | 20h : invisible |

Terminal Report (Axel)

| | |
|--|------------------------|
| AX3000 IP address | CSI < a (or CSI < 0 a) |
| Response: IP address <CR> | |
| Firmware revision | CSI < 1 a |
| Response: version <CR> | |
| Answerback message (set through the AX3000 Set-Up) | CSI < 4 a |
| Response: message | |
| Current session number | CSI < 5 a |
| Response: number <CR> | |
| Printer Status | CSI < 6 a |
| Response: OK <CR> or ERR <CR> | |

Terminal Report

| | |
|--|-----------|
| Cursor position report | Esc 5 |
| Response: Esc Y line col <CR> | |
| Terminal status | Esc 6 |
| Response: Esc 6 20h D <CR> | |
| Hardware configuration | Esc 20h 6 |
| Response: Esc 20h 6 T <CR> | |
| Hardware configuration (enhanced) | Esc " 6 |
| Response: Esc " 6) ! & D <CR> | |
| Answerback message (set through the AX3000 Set-Up) | Esc ! 6 |
| Response: Esc ! 6 message Esc 6 <CR> | |

**- 3 -
CHARACTER SETS**

This chapter deals with available AX3000 character sets.

The Platine terminal supports many character sets. These character sets are sorted by families:

- ANSI, PCTERM, SM94xx, PROLOGUE, QVT, TVI and 3151 families
- VT family
- WYSE family

Convention: in following character sets, for each character, the decimal, hexadecimal and octal values are given:

| | | | |
|-----------|---|-----------------|---|
| character | A | 41 65 101 | hexadecimal value decimal value octal value |
|-----------|---|-----------------|---|

3.1 - ANSI, PCTERM, SM94XX, PROLOGUE, QVT, TVI, 3151

The following table specifies available character sets for each family:

| | ANSI | PCTERM | SM94xx | PROLOGUE | QVT | TVI | 3151 |
|----------------------------|------|--------|--------|----------|-----|-----|------|
| PC 437 | ✓ | ✓ | | ✓ | ✓ | ✓ | ✓ |
| PC 850 | ✓ | ✓ | | ✓ | | | ✓ |
| PC 858 ^(*) | ✓ | ✓ | | ✓ | | | |
| PC 860 | ✓ | ✓ | | ✓ | | | |
| ISO 8859-1 | ✓ | | | | | | |
| ISO 8859-SG | ✓ | | | | | | |
| ISO 8859-15 ^(*) | ✓ | | | | | | |
| ISO 7-bit | ✓ | ✓ | ✓ | ✓ | ✓ | ✓ | |
| SM9400 | | | ✓ | | | | |
| Special graphics | | | | | | | ✓ |

^(*) only available with EURO option

PC-437 :

| | 0 | 1 | 2 | 3 | 4 | 5 | 6 | 7 |
|---|---------|----------|----------|----------|----------|----------|-----------|-----------|
| 0 | 0 0 | 10 16 | 20 32 | 30 48 | 40 64 | 50 80 | 60 96 | 70 112 |
| 1 | 1 1 | 11 17 | 21 33 | 31 49 | 41 65 | 51 81 | 61 97 | 71 113 |
| 2 | 2 2 | 12 18 | 22 34 | 32 50 | 42 66 | 52 82 | 62 98 | 72 114 |
| 3 | 3 3 | 13 19 | 23 35 | 33 51 | 43 67 | 53 83 | 63 99 | 73 115 |
| 4 | 4 4 | 14 20 | 24 36 | 34 52 | 44 68 | 54 84 | 64 100 | 74 116 |
| 5 | 5 5 | 15 21 | 25 37 | 35 53 | 45 69 | 55 85 | 65 101 | 75 117 |
| 6 | 6 6 | 16 22 | 26 38 | 36 54 | 46 70 | 56 86 | 66 102 | 76 118 |
| 7 | 7 7 | 17 23 | 27 39 | 37 55 | 47 71 | 57 87 | 67 103 | 77 119 |
| 8 | 8 8 | 18 24 | 28 40 | 38 56 | 48 72 | 58 88 | 68 104 | 78 120 |
| 9 | 9 9 | 19 25 | 29 41 | 39 57 | 49 73 | 59 89 | 69 105 | 79 121 |
| A | A 10 | 1A 26 | 2A 42 | 3A 58 | 4A 74 | 5A 90 | 6A 106 | 7A 122 |
| B | B 11 | 1B 27 | 2B 43 | 3B 59 | 4B 75 | 5B 91 | 6B 107 | 7B 123 |
| C | C 12 | 1C 28 | 2C 44 | 3C 60 | 4C 76 | 5C 92 | 6C 108 | 7C 124 |
| D | D 13 | 1D 29 | 2D 45 | 3D 61 | 4D 77 | 5D 93 | 6D 109 | 7D 125 |
| E | E 14 | 1E 30 | 2E 46 | 3E 62 | 4E 78 | 5E 94 | 6E 110 | 7E 126 |
| F | F 15 | 1F 31 | 2F 47 | 3F 63 | 4F 79 | 5F 95 | 6F 111 | 7F 127 |

| | 8 | 9 | A | B | C | D | E | F |
|---|-----------|-----------|-----------|-----------|-----------|-----------|-----------|-----------|
| 0 | 80 128 | 90 144 | A0 160 | B0 176 | C0 192 | D0 208 | E0 224 | F0 240 |
| 1 | 81 129 | 91 145 | A1 161 | B1 177 | C1 193 | D1 209 | E1 225 | F1 241 |
| 2 | 82 130 | 92 146 | A2 162 | B2 178 | C2 194 | D2 210 | E2 226 | F2 242 |
| 3 | 83 131 | 93 147 | A3 163 | B3 179 | C3 195 | D3 211 | E3 227 | F3 243 |
| 4 | 84 132 | 94 148 | A4 164 | B4 180 | C4 196 | D4 212 | E4 228 | F4 244 |
| 5 | 85 133 | 95 149 | A5 165 | B5 181 | C5 197 | D5 213 | E5 229 | F5 245 |
| 6 | 86 134 | 96 150 | A6 166 | B6 182 | C6 198 | D6 214 | E6 230 | F6 246 |
| 7 | 87 135 | 97 151 | A7 167 | B7 183 | C7 199 | D7 215 | E7 231 | F7 247 |
| 8 | 88 136 | 98 152 | A8 168 | B8 184 | C8 200 | D8 216 | E8 232 | F8 248 |
| 9 | 89 137 | 99 153 | A9 169 | B9 185 | C9 201 | D9 217 | E9 233 | F9 249 |
| A | 8A 138 | 9A 154 | AA 170 | BA 186 | CA 202 | DA 218 | EA 234 | FA 250 |
| B | 8B 139 | 9B 155 | AB 171 | BB 187 | CB 203 | DB 219 | EB 235 | FB 251 |
| C | 8C 140 | 9C 156 | AC 172 | BC 188 | CC 204 | DC 220 | EC 236 | FC 252 |
| D | 8D 141 | 9D 157 | AD 173 | BD 189 | CD 205 | DD 221 | ED 237 | FD 253 |
| E | 8E 142 | 9E 158 | AE 174 | BE 190 | CE 206 | DE 222 | EE 238 | FE 254 |
| F | 8F 143 | 9F 159 | AF 175 | BF 191 | CF 207 | DF 223 | EF 239 | FF 255 |

PC-850 :

| | 0 | 1 | 2 | 3 | 4 | 5 | 6 | 7 |
|---|------|-------|-------|------|------|------|------|------|
| 0 | 00 0 | 01 ▶ | 10 SP | 20 0 | 30 @ | 40 P | 50 ` | 60 p |
| 1 | 11 ☺ | 12 ◀ | 21 ! | 31 1 | 41 A | 51 Q | 61 a | 71 q |
| 2 | 22 ☹ | 23 ↕ | 32 " | 42 2 | 52 B | 62 R | 72 b | 82 r |
| 3 | 33 ♥ | 43 !! | 53 # | 63 3 | 73 C | 83 S | 93 c | 03 s |
| 4 | 44 ♦ | 54 ¶ | 64 \$ | 74 4 | 84 D | 94 T | 04 d | 14 t |
| 5 | 55 ♣ | 65 § | 75 % | 85 5 | 95 E | 05 U | 15 e | 25 u |
| 6 | 66 ♠ | 76 ↕ | 86 & | 96 6 | 06 F | 16 V | 26 f | 36 v |
| 7 | 77 • | 87 ■ | 97 ' | 07 7 | 17 G | 27 W | 37 g | 47 w |
| 8 | 88 ◼ | 98 ↑ | 08 (| 18 8 | 28 H | 38 X | 48 h | 58 x |
| 9 | 99 ○ | 09 ↓ | 19) | 29 9 | 39 I | 49 Y | 59 i | 69 y |
| A | A0 ◼ | A1 → | A2 * | A3 : | A4 J | A5 Z | A6 j | A7 z |
| B | B0 ♂ | B1 ← | B2 + | B3 ; | B4 K | B5 [| B6 k | B7 { |
| C | C0 ♀ | C1 - | C2 , | C3 < | C4 L | C5 \ | C6 l | C7 |
| D | D0 ♪ | D1 ↔ | D2 - | D3 = | D4 M | D5] | D6 m | D7 } |
| E | E0 ♪ | E1 ▲ | E2 . | E3 > | E4 N | E5 ^ | E6 n | E7 ~ |
| F | F0 * | F1 ▼ | F2 / | F3 ? | F4 O | F5 _ | F6 o | F7 ð |

| | 8 | 9 | A | B | C | D | E | F |
|---|------|------|------|------|------|------|------|------|
| 0 | 80 Ç | 90 É | A0 á | B0 ◻ | C0 L | D0 ö | E0 Ó | F0 - |
| 1 | 81 ü | 91 æ | A1 í | B1 ◻ | C1 L | D1 ð | E1 ß | F1 ± |
| 2 | 82 é | 92 Æ | A2 ó | B2 ◻ | C2 T | D2 Ê | E2 Ò | F2 = |
| 3 | 83 â | 93 ô | A3 ú | B3 | C3 T | D3 Ë | E3 Õ | F3 ¼ |
| 4 | 84 ä | 94 ö | A4 ñ | B4 | C4 - | D4 È | E4 õ | F4 ¶ |
| 5 | 85 à | 95 ò | A5 ñ | B5 Á | C5 † | D5 r | E5 Ö | F5 § |
| 6 | 86 ã | 96 û | A6 ã | B6 Â | C6 ã | D6 í | E6 µ | F6 ÷ |
| 7 | 87 ç | 97 ù | A7 ° | B7 À | C7 Æ | D7 î | E7 þ | F7 ÷ |
| 8 | 88 ê | 98 ÿ | A8 ¿ | B8 © | C8 L | D8 ï | E8 þ | F8 ° |
| 9 | 89 ë | 99 Ö | A9 ® | B9 ¶ | C9 ¶ | D9 J | E9 Ú | F9 " |
| A | 90 è | 00 Ü | A0 ¶ | B0 ¶ | C0 ¶ | D0 ¶ | E0 Ú | F0 · |
| B | 91 ì | 01 ø | A1 ½ | B1 ¶ | C1 ¶ | D1 ¶ | E1 Û | F1 1 |
| C | 92 î | 02 £ | A2 ¼ | B2 ¶ | C2 ¶ | D2 ¶ | E2 Ý | F2 2 |
| D | 93 ï | 03 Ø | A3 i | B3 ¢ | C3 = | D3 I | E3 Ý | F3 3 |
| E | 94 Ä | 04 X | A4 « | B4 ¥ | C4 ¶ | D4 I | E4 - | F4 ■ |
| F | 95 Å | 05 f | A5 » | B6 ¶ | C6 ¶ | D6 ¶ | E6 ' | F6 ¤ |

PC-858 :

(Available only with Euro option)

| | 0 | 1 | 2 | 3 | 4 | 5 | 6 | 7 | | | | | | |
|---|---------|----------|----|----------|---|----------|---|----------|---|----------|---|-----------|---|-----------|
| 0 | 0 0 | 10 16 | SP | 20 32 | 0 | 30 48 | @ | 40 64 | P | 50 80 | ` | 60 96 | p | 70 112 |
| 1 | 1 1 | 11 17 | ! | 21 33 | 1 | 31 49 | A | 41 65 | Q | 51 81 | a | 61 97 | q | 71 113 |
| 2 | 2 2 | 12 18 | " | 22 34 | 2 | 32 50 | B | 42 66 | R | 52 82 | b | 62 98 | r | 72 114 |
| 3 | 3 3 | 13 19 | #! | 23 35 | 3 | 33 51 | C | 43 67 | S | 53 83 | c | 63 99 | s | 73 115 |
| 4 | 4 4 | 14 20 | \$ | 24 36 | 4 | 34 52 | D | 44 68 | T | 54 84 | d | 64 100 | t | 74 116 |
| 5 | 5 5 | 15 21 | % | 25 37 | 5 | 35 53 | E | 45 69 | U | 55 85 | e | 65 101 | u | 75 117 |
| 6 | 6 6 | 16 22 | & | 26 38 | 6 | 36 54 | F | 46 70 | V | 56 86 | f | 66 102 | v | 76 118 |
| 7 | 7 7 | 17 23 | ' | 27 39 | 7 | 37 55 | G | 47 71 | W | 57 87 | g | 67 103 | w | 77 119 |
| 8 | 8 8 | 18 24 | (| 28 40 | 8 | 38 56 | H | 48 72 | X | 58 88 | h | 68 104 | x | 78 120 |
| 9 | 9 9 | 19 25 |) | 29 41 | 9 | 39 57 | I | 49 73 | Y | 59 89 | i | 69 105 | y | 79 121 |
| A | A 10 | 1A 26 | * | 2A 34 | : | 3A 51 | J | 4A 74 | Z | 5A 85 | j | 6A 106 | z | 7A 122 |
| B | B 11 | 1B 27 | + | 2B 43 | ; | 3B 59 | K | 4B 75 | [| 5B 86 | k | 6B 107 | { | 7B 123 |
| C | C 12 | 1C 28 | , | 2C 44 | < | 3C 60 | L | 4C 76 | \ | 5C 92 | l | 6C 108 | | 7C 124 |
| D | D 13 | 1D 29 | - | 2D 45 | = | 3D 61 | M | 4D 77 |] | 5D 93 | m | 6D 109 | } | 7D 125 |
| E | E 14 | 1E 30 | . | 2E 46 | > | 3E 62 | N | 4E 78 | ^ | 5E 94 | n | 6E 110 | ~ | 7E 126 |
| F | F 15 | 1F 31 | / | 2F 47 | ? | 3F 63 | O | 4F 79 | _ | 5F 95 | o | 6F 111 | Δ | 7F 127 |

| | 8 | 9 | A | B | C | D | E | F | |
|---|-----------------------|-----------------------|-----------------------|-----------------------|-----------------------|-----------------------|-----------------------|---|------------------|
| 0 | Ç 80 128 200 | É 90 144 220 | á A0 160 240 | ■ B0 176 260 | L C0 192 300 | ø D0 208 320 | Ó E0 224 340 | - | F0 240 360 |
| 1 | ü 81 129 201 | æ 91 145 221 | í A1 161 241 | ■ B1 177 261 | ł C1 193 301 | Ð D1 209 321 | ß E1 225 341 | ± | F1 241 361 |
| 2 | é 82 130 202 | Æ 92 146 222 | ó A2 162 242 | ■ B2 178 262 | T C2 194 302 | Ê D2 210 322 | Ô E2 226 342 | = | F2 242 362 |
| 3 | â 83 131 203 | ô 93 147 223 | ú A3 163 243 | B3 179 263 | † C3 195 303 | Ë D3 211 323 | Ò E3 227 343 | ¼ | F3 243 363 |
| 4 | ä 84 132 204 | ö 94 148 224 | ñ A4 164 244 | † B4 180 264 | - C4 196 304 | È D4 212 324 | ō E4 228 344 | ¶ | F4 244 364 |
| 5 | à 85 133 205 | ò 95 149 225 | Ñ A5 165 245 | Á B5 181 265 | † C5 197 305 | € D5 213 325 | Ö E5 229 345 | § | F5 245 365 |
| 6 | â 86 134 206 | û 96 150 226 | ª A6 166 246 | Â B6 182 266 | ã C6 198 306 | í D6 214 326 | µ E6 230 346 | ÷ | F6 246 366 |
| 7 | ç 87 135 207 | ù 97 151 227 | º A7 167 247 | À B7 183 267 | Ä C7 199 307 | î D7 215 327 | þ E7 231 347 | » | F7 247 367 |
| 8 | ê 88 136 210 | ÿ 98 152 230 | ¿ A8 168 250 | © B8 184 270 | Ł C8 200 310 | ï D8 216 330 | þ E8 232 350 | ° | F8 248 370 |
| 9 | ë 89 137 211 | ÿ 99 153 231 | ® A9 169 251 | ¶ B9 185 271 | Œ C9 201 311 | ĵ D9 217 331 | ú E9 233 351 | ¨ | F9 249 371 |
| A | è 8A 138 212 | ÿ 9A 154 232 | ¬ AA 170 252 | BA 186 272 | ƒ CA 202 312 | ŕ DA 218 332 | Û EA 234 352 | · | FA 250 372 |
| B | ï 8B 139 213 | ø 9B 155 233 | ½ AB 171 253 | ¶ BB 187 273 | ƒ CB 203 313 | ■ DB 219 333 | Ü EB 235 353 | 1 | FB 251 373 |
| C | î 8C 140 214 | £ 9C 156 234 | ¼ AC 172 254 | ¶ BC 188 274 | ƒ CC 204 314 | ■ DC 220 334 | Ý EC 236 354 | 2 | FC 252 374 |
| D | ì 8D 141 215 | Ø 9D 157 235 | ı AD 173 255 | ¢ BD 189 275 | = CD 205 315 | ı DD 221 335 | Ÿ ED 237 355 | 3 | FD 253 375 |
| E | Ä 8E 142 216 | X 9E 158 236 | « AE 174 256 | ¥ BE 190 276 | ƒ CE 206 316 | ı DE 222 336 | — EE 238 356 | ■ | FE 254 376 |
| F | Å 8F 143 217 | f 9F 159 237 | » AF 175 257 | ł BF 191 277 | α CF 207 317 | ■ DF 223 337 | ' | ' | FF 255 377 |

PC-860 :

| | 0 | 1 | 2 | 3 | 4 | 5 | 6 | 7 |
|---|------|-------|-------|------|------|------|------|------|
| 0 | 00 0 | 01 ▶ | 10 SP | 20 0 | 30 @ | 40 P | 50 ` | 60 p |
| 1 | 11 ☺ | 12 ◀ | 21 ! | 31 1 | 41 A | 51 Q | 61 a | 71 q |
| 2 | 22 ☹ | 23 ↕ | 32 " | 42 2 | 52 B | 62 R | 72 b | 82 r |
| 3 | 33 ♥ | 43 !! | 53 # | 63 3 | 73 C | 83 S | 93 c | 03 s |
| 4 | 44 ♦ | 54 ¶ | 64 \$ | 74 4 | 84 D | 94 T | 04 d | 14 t |
| 5 | 55 ♣ | 65 § | 75 % | 85 5 | 95 E | 05 U | 15 e | 25 u |
| 6 | 66 ♠ | 76 ↕ | 86 & | 96 6 | 06 F | 16 V | 26 f | 36 v |
| 7 | 77 • | 87 ■ | 97 ' | 07 7 | 17 G | 27 W | 37 g | 47 w |
| 8 | 88 ◼ | 98 ↑ | 08 (| 18 8 | 28 H | 38 X | 48 h | 58 x |
| 9 | 99 ○ | 09 ↓ | 19) | 29 9 | 39 I | 49 Y | 59 i | 69 y |
| A | A0 ◼ | A1 → | A2 * | A3 : | A4 J | A5 Z | A6 j | A7 z |
| B | B0 ♂ | B1 ← | B2 + | B3 ; | B4 K | B5 [| B6 k | B7 { |
| C | C0 ♀ | C1 - | C2 , | C3 < | C4 L | C5 \ | C6 l | C7 |
| D | D0 ♪ | D1 ↔ | D2 - | D3 = | D4 M | D5] | D6 m | D7 } |
| E | E0 ♪ | E1 ▲ | E2 . | E3 > | E4 N | E5 ^ | E6 n | E7 ~ |
| F | F0 * | F1 ▼ | F2 / | F3 ? | F4 O | F5 _ | F6 o | F7 Δ |

| | 8 | 9 | A | B | C | D | E | F |
|---|------|------|-------|------|--------|--------|-------|-------|
| 0 | 80 Ç | 90 É | A0 á | B0 ◻ | C0 L | D0 ll | E0 α | F0 ≡ |
| 1 | 81 ü | 91 Ä | A1 í | B1 ◻ | C1 ll | D1 ll | E1 ß | F1 ± |
| 2 | 82 é | 92 È | A2 ó | B2 ◻ | C2 T | D2 ll | E2 Γ | F2 ≥ |
| 3 | 83 â | 93 ò | A3 ú | B3 | C3 ll | D3 ll | E3 π | F3 ≤ |
| 4 | 84 ã | 94 õ | A4 ñ | B4 | C4 - | D4 ll | E4 Σ | F4 |
| 5 | 85 à | 95 ò | A5 ñ | B5 | C5 + | D5 F | E5 σ | F5 J |
| 6 | 86 Á | 96 Ú | A6 ã | B6 | C6 F | D6 ll | E6 μ | F6 ÷ |
| 7 | 87 ç | 97 ù | A7 ø | B7 | C7 | D7 | E7 τ | F7 ≈ |
| 8 | 88 ê | 98 ì | A8 ç | B8 | C8 ll | D8 ll | E8 φ | F8 ° |
| 9 | 89 Ê | 99 Ö | A9 ò | B9 | C9 ll | D9 ll | E9 ⊗ | F9 • |
| A | 8A è | 9A Ü | A10 ñ | B10 | C10 ll | D10 ll | E10 Ω | F10 · |
| B | 8B í | 9B Ç | A11 ½ | B11 | C11 ll | D11 ll | E11 δ | F11 √ |
| C | 8C Ô | 9C £ | A12 ¼ | B12 | C12 ll | D12 ll | E12 ∞ | F12 n |
| D | 8D ì | 9D ù | A13 i | B13 | C13 = | D13 ll | E13 φ | F13 2 |
| E | 8E Æ | 9E Þ | A14 « | B14 | C14 ll | D14 ll | E14 ε | F14 ■ |
| F | 8F Â | 9F Ó | A15 » | B15 | C15 ll | D15 ll | E15 ñ | F15 □ |

ISO 8859-1:

| | 0 | 1 | 2 | 3 | 4 | 5 | 6 | 7 |
|---|----|----|----|----|----|----|----|----|
| 0 | 00 | 01 | 02 | 03 | 04 | 05 | 06 | 07 |
| 1 | 08 | 09 | 0A | 0B | 0C | 0D | 0E | 0F |
| 2 | 10 | 11 | 12 | 13 | 14 | 15 | 16 | 17 |
| 3 | 18 | 19 | 1A | 1B | 1C | 1D | 1E | 1F |
| 4 | 20 | 21 | 22 | 23 | 24 | 25 | 26 | 27 |
| 5 | 28 | 29 | 2A | 2B | 2C | 2D | 2E | 2F |
| 6 | 30 | 31 | 32 | 33 | 34 | 35 | 36 | 37 |
| 7 | 38 | 39 | 3A | 3B | 3C | 3D | 3E | 3F |
| 8 | 40 | 41 | 42 | 43 | 44 | 45 | 46 | 47 |
| 9 | 48 | 49 | 4A | 4B | 4C | 4D | 4E | 4F |
| A | 50 | 51 | 52 | 53 | 54 | 55 | 56 | 57 |
| B | 58 | 59 | 5A | 5B | 5C | 5D | 5E | 5F |
| C | 60 | 61 | 62 | 63 | 64 | 65 | 66 | 67 |
| D | 68 | 69 | 6A | 6B | 6C | 6D | 6E | 6F |
| E | 70 | 71 | 72 | 73 | 74 | 75 | 76 | 77 |
| F | 78 | 79 | 7A | 7B | 7C | 7D | 7E | 7F |

| | 8 | 9 | A | B | C | D | E | F |
|---|-----|-----|-----|-----|-----|-----|-----|-----|
| 0 | 80 | 81 | 82 | 83 | 84 | 85 | 86 | 87 |
| 1 | 88 | 89 | 8A | 8B | 8C | 8D | 8E | 8F |
| 2 | 90 | 91 | 92 | 93 | 94 | 95 | 96 | 97 |
| 3 | 98 | 99 | 9A | 9B | 9C | 9D | 9E | 9F |
| 4 | 100 | 101 | 102 | 103 | 104 | 105 | 106 | 107 |
| 5 | 108 | 109 | 10A | 10B | 10C | 10D | 10E | 10F |
| 6 | 110 | 111 | 112 | 113 | 114 | 115 | 116 | 117 |
| 7 | 118 | 119 | 11A | 11B | 11C | 11D | 11E | 11F |
| 8 | 120 | 121 | 122 | 123 | 124 | 125 | 126 | 127 |
| 9 | 128 | 129 | 12A | 12B | 12C | 12D | 12E | 12F |
| A | 130 | 131 | 132 | 133 | 134 | 135 | 136 | 137 |
| B | 138 | 139 | 13A | 13B | 13C | 13D | 13E | 13F |
| C | 140 | 141 | 142 | 143 | 144 | 145 | 146 | 147 |
| D | 148 | 149 | 14A | 14B | 14C | 14D | 14E | 14F |
| E | 150 | 151 | 152 | 153 | 154 | 155 | 156 | 157 |
| F | 158 | 159 | 15A | 15B | 15C | 15D | 15E | 15F |

Note: for ANSI RS/6000 emulation, the ASCII characters from 80h to 9Fh are blank characters.

ISO 8859-SG:

| | 0 | 1 | 2 | 3 | 4 | 5 | 6 | 7 |
|---|----------------|---|----|---|---|---|---|---|
| 0 | α | 0 | SP | 0 | @ | P | ` | p |
| 1 | Γ | 1 | ! | 1 | A | Q | a | q |
| 2 | π | 2 | " | 2 | B | R | b | r |
| 3 | Σ | 3 | # | 3 | C | S | c | s |
| 4 | σ | 4 | \$ | 4 | D | T | d | t |
| 5 | τ | 5 | % | 5 | E | U | e | u |
| 6 | Φ | 6 | & | 6 | F | V | f | v |
| 7 | Θ | 7 | ' | 7 | G | W | g | w |
| 8 | Ω | 8 | (| 8 | H | X | h | x |
| 9 | δ | 9 |) | 9 | I | Y | i | y |
| A | ∞ | A | * | A | J | Z | j | z |
| B | ε | B | + | B | K | [| k | { |
| C | η | C | , | C | L | \ | l | |
| D | ÿ | D | - | D | M |] | m | } |
| E | P _t | E | . | E | N | ^ | n | ~ |
| F | f | F | / | F | O | _ | o | Δ |

| | 8 | 9 | A | B | C | D | E | F |
|---|----|----|---|---|---|---|---|---|
| 0 | L | ll | o | o | À | Ð | à | ö |
| 1 | l | l | i | ± | Á | Ñ | á | ñ |
| 2 | T | T | ç | z | Â | Ò | â | ò |
| 3 | l | ll | £ | z | Ã | Ó | ã | ó |
| 4 | - | l | ¤ | ' | Ä | Ô | ä | ö |
| 5 | + | F | ¥ | µ | Å | Õ | å | ö |
| 6 | f | ll | l | ¶ | Æ | Ö | æ | ö |
| 7 | l | ll | § | · | Ç | × | ç | ÷ |
| 8 | ll | ll | ¨ | ¸ | È | Ø | è | φ |
| 9 | ll | ll | © | 1 | É | Ù | é | ù |
| A | ll | ll | ® | 2 | Ê | Ú | ê | ú |
| B | ll | ll | « | » | Ë | Û | ë | û |
| C | ll | ll | ¬ | ¼ | Ì | Ü | ì | ü |
| D | = | ll | — | ½ | Í | Ý | í | ý |
| E | ll | ll | ® | ¾ | Î | Þ | î | þ |
| F | ll | ll | — | ¿ | Ï | ß | ï | ÿ |

ISO 8859-15:

(only available with the Euro option)

| | 0 | 1 | 2 | 3 | 4 | 5 | 6 | 7 | | | | | | | |
|---|---|---------------|----------------|----|----------------|---|----------------|---|-----------------|---|-----------------|---|------------------|---|------------------|
| 0 | | 0 0 | 10 16 20 | SP | 20 32 40 | 0 | 30 48 60 | @ | 40 64 120 | P | 50 80 120 | ` | 60 96 140 | p | 70 112 160 |
| 1 | ☺ | 1 1 | 11 17 | ! | 21 33 41 | 1 | 31 49 61 | A | 41 65 101 | Q | 51 81 121 | a | 61 97 141 | q | 71 113 161 |
| 2 | ☹ | 2 2 | 12 18 22 | " | 22 34 42 | 2 | 32 50 62 | B | 42 66 102 | R | 52 82 122 | b | 62 98 142 | r | 72 114 162 |
| 3 | ♥ | 3 3 | 13 19 23 | # | 23 35 43 | 3 | 33 51 63 | C | 43 67 103 | S | 53 83 123 | c | 63 99 143 | s | 73 115 163 |
| 4 | ♦ | 4 4 | 14 20 24 | \$ | 24 36 44 | 4 | 34 52 64 | D | 44 68 104 | T | 54 84 124 | d | 64 100 144 | t | 74 116 164 |
| 5 | ♣ | 5 5 | 15 21 25 | % | 25 37 45 | 5 | 35 53 65 | E | 45 69 105 | U | 55 85 125 | e | 65 101 145 | u | 75 117 165 |
| 6 | ♠ | 6 6 | 16 22 26 | & | 26 38 46 | 6 | 36 54 66 | F | 46 70 106 | V | 56 86 126 | f | 66 102 146 | v | 76 118 166 |
| 7 | • | 7 7 | 17 23 27 | ' | 27 39 47 | 7 | 37 55 67 | G | 47 71 107 | W | 57 87 127 | g | 67 103 147 | w | 77 119 167 |
| 8 | ◼ | 8 8 | 18 24 30 | (| 28 40 50 | 8 | 38 56 70 | H | 48 72 110 | X | 58 88 130 | h | 68 104 150 | x | 78 120 170 |
| 9 | ○ | 9 9 | 19 25 31 |) | 29 41 51 | 9 | 39 57 71 | I | 49 73 111 | Y | 59 89 131 | i | 69 105 151 | y | 79 121 171 |
| A | ◼ | A 10 12 | 1A 17 21 | * | 2A 32 42 | | 3A 51 63 | J | 4A 64 102 | Z | 5A 81 121 | j | 6A 97 141 | z | 7A 119 169 |
| B | ♂ | B 11 13 | 1B 18 22 | + | 2B 34 44 | | 3B 52 64 | K | 4B 66 104 | [| 5B 81 121 | k | 6B 97 141 | { | 7B 119 169 |
| C | ♀ | C 12 14 | 1C 19 23 | , | 2C 36 46 | | 3C 54 66 | L | 4C 68 106 | \ | 5C 83 123 | l | 6C 99 143 | | 7C 121 171 |
| D | ♫ | D 13 15 | 1D 20 24 | - | 2D 32 42 | | 3D 50 62 | M | 4D 64 102 |] | 5D 79 119 | m | 6D 105 151 | } | 7D 127 177 |
| E | ♬ | E 14 16 | 1E 21 25 | . | 2E 34 44 | | 3E 52 64 | N | 4E 66 104 | ^ | 5E 81 121 | n | 6E 97 141 | ~ | 7E 119 169 |
| F | * | F 15 17 | 1F 22 26 | / | 2F 36 46 | | 3F 54 66 | O | 4F 68 106 | _ | 5F 83 123 | o | 6F 99 143 | Δ | 7F 121 171 |

| | 8 | 9 | A | B | C | D | E | F | | | | | | | | |
|---|---|------------------|---|------------------|---|-------------------|---|-------------------|---|------------------|---|------------------|---|-------------------|---|-------------------|
| 0 | | 80 128 200 | - | 90 144 220 | | A0 160 240 | ° | B0 176 260 | À | C0 192 300 | Ð | D0 208 320 | à | E0 224 340 | ð | F0 240 360 |
| 1 | ♦ | 81 129 201 | - | 91 145 221 | i | A1 161 241 | ± | B1 177 261 | Á | C1 193 301 | Ñ | D1 209 321 | á | E1 225 341 | ñ | F1 241 361 |
| 2 | ☼ | 82 130 202 | - | 92 146 222 | ç | A2 162 242 | ² | B2 178 262 | Â | C2 194 302 | Ò | D2 210 322 | â | E2 226 342 | ò | F2 242 362 |
| 3 | ☽ | 83 131 203 | - | 93 147 223 | £ | A3 163 243 | ³ | B3 179 263 | Ã | C3 195 303 | Ó | D3 211 323 | ã | E3 227 343 | ó | F3 243 363 |
| 4 | ☿ | 84 132 204 | - | 94 148 224 | € | A4 164 244 | Ž | B4 180 264 | Ä | C4 196 304 | Ô | D4 212 324 | ä | E4 228 344 | ö | F4 244 364 |
| 5 | ♁ | 85 133 205 | † | 95 149 225 | ¥ | A5 165 245 | µ | B5 181 265 | Å | C5 197 305 | Ö | D5 213 325 | å | E5 229 345 | ö | F5 245 365 |
| 6 | ♂ | 86 134 206 | ‡ | 96 150 226 | Š | A6 166 246 | ¶ | B6 182 266 | Æ | C6 198 306 | Ö | D6 214 326 | æ | E6 230 346 | ö | F6 246 366 |
| 7 | ° | 87 135 207 | ‡ | 97 151 227 | Š | A7 167 247 | · | B7 183 267 | Ç | C7 199 307 | × | D7 215 327 | ç | E7 231 347 | ÷ | F7 247 367 |
| 8 | ± | 88 136 210 | ‡ | 98 152 230 | Š | A8 168 250 | Ž | B8 184 270 | È | C8 200 310 | Ø | D8 216 330 | è | E8 232 350 | ø | F8 248 370 |
| 9 | ¶ | 89 137 211 | ‡ | 99 153 231 | © | A9 169 251 | ¹ | B9 185 271 | É | C9 201 311 | Ù | D9 217 331 | é | E9 233 351 | ù | F9 249 371 |
| A | ¥ | 8A 138 212 | ≤ | 9A 154 232 | ® | A10 170 252 | º | B10 186 272 | Ê | CA 202 312 | Ú | DA 218 332 | ê | E10 234 352 | ú | F10 250 372 |
| B | ¶ | 8B 139 213 | ≥ | 9B 155 233 | « | AB 171 253 | » | BB 187 273 | Ë | CB 203 313 | Û | DB 219 333 | ë | E11 235 353 | û | F11 251 373 |
| C | ∟ | 8C 140 214 | ∏ | 9C 156 234 | ¬ | AC 172 254 | œ | BC 188 274 | Ï | CC 204 314 | Ü | DC 220 334 | ï | EC 236 354 | ü | FC 252 374 |
| D | ∟ | 8D 141 215 | ≠ | 9D 157 235 | ∑ | AD 173 255 | œ | BD 189 275 | Í | CD 205 315 | Ý | DD 221 335 | í | ED 237 355 | ý | FD 253 375 |
| E | ∟ | 8E 142 216 | £ | 9E 158 236 | ® | AE 174 256 | ÿ | BE 190 276 | Î | CE 206 316 | Þ | DE 222 336 | î | EE 238 356 | þ | FE 254 376 |
| F | † | 8F 143 217 | • | 9F 159 237 | - | AF 175 257 | ¿ | BF 191 277 | Ï | CF 207 317 | ß | DF 223 337 | ï | EF 239 357 | ÿ | FF 255 377 |

Note: for ANSI RS/6000 emulation, the ASCII characters from 80h to 9Fh are blank characters.

National ISO 7-Bit:

Many characters of the National ISO 7-Bit set are dependent of the national keyboard selected through the AX3000 Set-Up. The following table describes the character set associated with the US keyboard:

| | 0 | 1 | 2 | 3 | 4 | 5 | 6 | 7 |
|---|-----------|-----------|----------|---------|---------|---------|---------|---------|
| 0 | NUL 00 | DLE 10 | SP 20 | 0 30 | @ 40 | P 50 | ` 60 | p 70 |
| 1 | SOH 01 | DC1 11 | ! 21 | 1 31 | A 41 | Q 51 | a 61 | q 71 |
| 2 | STX 02 | DC2 12 | " 22 | 2 32 | B 42 | R 52 | b 62 | r 72 |
| 3 | ETX 03 | DC3 13 | # 23 | 3 33 | C 43 | S 53 | c 63 | s 73 |
| 4 | EOT 04 | DC4 14 | \$ 24 | 4 34 | D 44 | T 54 | d 64 | t 74 |
| 5 | ENQ 05 | NAK 15 | % 25 | 5 35 | E 45 | U 55 | e 65 | u 75 |
| 6 | ACK 06 | SYN 16 | & 26 | 6 36 | F 46 | V 56 | f 66 | v 76 |
| 7 | BEL 07 | ETB 17 | ' 27 | 7 37 | G 47 | W 57 | g 67 | w 77 |
| 8 | BS 08 | CAN 18 | (28 | 8 38 | H 48 | X 58 | h 68 | x 78 |
| 9 | HT 09 | EM 19 |) 29 | 9 39 | I 49 | Y 59 | i 69 | y 79 |
| A | LF 0A | SUB 1A | * 2A | : | J 4A | Z 5A | j 6A | z 7A |
| B | VT 0B | ESC 1B | + 2B | ; | K 4B | [5B | k 6B | { 7B |
| C | FF 0C | FS 1C | , 2C | < | L 4C | \ 5C | l 6C | 7C |
| D | CR 0D | GS 1D | - 2D | = | M 4D |] 5D | m 6D | } 7D |
| E | SO 0E | RS 1E | . 2E | > | N 4E | ^ 5E | n 6E | ~ 7E |
| F | SI 0F | US 1F | / 2F | ? | O 4F | _ 5F | o 6F | 7F |

The following table shows the characters that differ from the national set (US keyboard):

| | Hexadecimal code of the replaced characters | | | | | | | | | | | |
|-------------|---|----|----|----|----|----|----|----|----|----|----|----|
| | 23 | 40 | 5B | 5C | 5D | 5E | 5F | 60 | 7B | 7C | 7D | 7E |
| France | £ | à | ° | ç | § | ^ | _ | ` | é | ù | è | .. |
| U.K | £ | @ | [| \ |] | ^ | _ | ` | { | | } | ~ |
| Germany | # | § | Ä | Ö | Ü | ^ | _ | ` | ä | ö | ü | ß |
| Italy | £ | § | ° | ç | é | ^ | _ | ù | à | ò | è | ì |
| Spain | £ | § | i | Ñ | ¿ | ^ | _ | ` | ° | ñ | ç | ~ |
| Switzerland | ù | à | é | ç | è | î | è | ô | ä | ö | ü | û |
| Portugal | # | @ | Ã | Ç | Ö | ^ | _ | ` | ã | ç | õ | ~ |

SM9400 :

| | 0 | 1 | 2 | 3 | 4 | 5 | 6 | 7 | |
|---|---------------|----------------|----|----------------|---------------------|----------------------|----------------------|-----------------------|-----------------------|
| 0 | 0 0 0 | 10 16 20 | SP | 20 32 40 | 0 30 48 60 | @ 40 64 100 | P 50 80 120 | ` 60 96 140 | p 70 112 160 |
| 1 | 1 1 1 | 11 17 21 | ! | 21 31 33 | 1 31 49 61 | A 41 65 101 | Q 51 81 121 | a 61 97 141 | q 71 113 161 |
| 2 | 2 2 2 | 12 18 22 | " | 22 34 42 | 2 32 50 62 | B 42 66 102 | R 52 82 122 | b 62 98 142 | r 72 114 162 |
| 3 | 3 3 3 | 13 19 23 | # | 23 35 43 | 3 33 51 63 | C 43 67 103 | S 53 83 123 | c 63 99 143 | s 73 115 163 |
| 4 | 4 4 4 | 14 20 24 | \$ | 24 36 44 | 4 34 52 64 | D 44 68 104 | T 54 84 124 | d 64 100 144 | t 74 116 164 |
| 5 | 5 5 5 | 15 21 25 | % | 25 37 45 | 5 35 53 65 | E 45 69 105 | U 55 85 125 | e 65 101 145 | u 75 117 165 |
| 6 | 6 6 6 | 16 22 26 | & | 26 38 46 | 6 36 54 66 | F 46 70 106 | V 56 86 126 | f 66 102 146 | v 76 118 166 |
| 7 | 7 7 7 | 17 23 27 | ' | 27 39 47 | 7 37 55 67 | G 47 71 107 | W 57 87 127 | g 67 103 147 | w 77 119 167 |
| 8 | 8 8 8 | 18 24 30 | (| 28 40 50 | 8 38 56 70 | H 48 72 110 | X 58 88 130 | h 68 104 150 | x 78 120 170 |
| 9 | 9 9 9 | 19 25 31 |) | 29 41 51 | 9 39 57 71 | I 49 73 111 | Y 59 89 131 | i 69 105 151 | y 79 121 171 |
| A | A 10 12 | 1A 26 32 | * | 2A 42 52 | 3A 53 72 | J 4A 74 112 | Z 5A 85 132 | j 6A 96 142 | z 7A 122 172 |
| B | B 11 13 | 1B 27 33 | + | 2B 43 53 | 3B 59 73 | K 4B 75 113 | [5B 87 133 | k 6B 107 153 | { 7B 123 173 |
| C | C 12 14 | 1C 28 34 | , | 2C 44 54 | 3C 60 74 | L 4C 76 114 | \ 5C 92 134 | l 6C 108 154 | 7C 124 174 |
| D | D 13 15 | 1D 29 35 | - | 2D 45 55 | 3D 61 75 | M 4D 77 115 |] 5D 93 135 | m 6D 109 155 | } 7D 125 175 |
| E | E 14 16 | 1E 30 36 | . | 2E 46 56 | 3E 62 76 | N 4E 78 116 | ^ 5E 94 136 | n 6E 110 156 | ~ 7E 126 176 |
| F | F 15 17 | 1F 31 37 | / | 2F 47 57 | 3F 63 77 | O 4F 79 117 | _ 5F 95 137 | o 6F 111 157 | 7F 127 177 |

| | 8 | 9 | A | B | C | D | E | F |
|---|------------------|------------------|-----------------|-----------------|-----------------|-----------------|-----------------|-------------------|
| 0 | 80 128 200 | 90 144 220 | Å 160 240 | æ 176 260 | ø 192 300 | Γ 208 320 | Г 224 340 | F 0 240 360 |
| 1 | 81 129 201 | 91 145 221 | Ä 161 241 | ç 177 261 | œ 193 301 | Л 209 321 | Л 225 341 | F 1 241 361 |
| 2 | 82 130 202 | 92 146 222 | Æ 162 242 | é 178 262 | ú 194 302 | Л 210 322 | Л 226 342 | F 2 242 362 |
| 3 | 83 131 203 | 93 147 223 | Ç 163 243 | è 179 263 | ù 195 303 | Л 211 323 | — 227 343 | F 3 243 363 |
| 4 | 84 132 204 | 94 148 224 | É 164 244 | ê 180 264 | û 196 304 | Г 212 324 | Г 228 344 | F 4 244 364 |
| 5 | 85 133 205 | 95 149 225 | Ñ 165 245 | ë 181 265 | ü 197 305 | Л 213 325 | Г 229 345 | F 5 245 365 |
| 6 | 86 134 206 | 96 150 226 | Ö 166 246 | í 182 266 | ß 198 306 | Л 214 326 | Г 230 346 | F 6 246 366 |
| 7 | 87 135 207 | 97 151 227 | Ø 167 247 | ì 183 267 | µ 199 307 | Г 215 327 | Г 231 347 | F 7 247 367 |
| 8 | 88 136 210 | 98 152 230 | Œ 168 250 | î 184 270 | ° 198 310 | Г 216 330 | Г 232 350 | F 8 248 370 |
| 9 | 89 137 211 | 99 153 231 | Ł 169 251 | ï 185 271 | § 201 311 | Г 217 331 | Г 233 351 | F 9 249 371 |
| A | 8A 138 212 | 9A 154 232 | Ū 170 252 | ı 186 272 | ± 202 312 | Г 218 332 | Г 234 352 | F A 250 372 |
| B | 8B 139 213 | 9B 155 233 | á 171 253 | ñ 187 273 | ı 203 313 | Г 219 333 | Г 235 353 | F B 251 373 |
| C | 8C 140 214 | 9C 156 234 | à 172 254 | ó 188 274 | ¿ 204 314 | → 220 334 | → 236 354 | F C 252 374 |
| D | 8D 141 215 | 9D 157 235 | â 173 255 | ò 189 275 | £ 205 315 | ← 221 335 | ← 237 355 | F D 253 375 |
| E | 8E 142 216 | 9E 158 236 | ã 174 256 | ô 190 276 | ¨ 206 316 | ↑ 222 336 | ↑ 238 356 | F E 254 376 |
| F | 8F 143 217 | 9F 159 237 | ä 175 257 | ö 191 277 | ˆ 207 317 | ↓ 223 337 | ↓ 239 357 | F F 255 377 |

Special Graphics :

| | | | | | | | | |
|---|---|----|----|----|----|-----|-----|-----|
| 0 | 0 | 10 | 20 | 30 | 40 | 50 | 60 | 70 |
| 0 | 0 | 16 | 32 | 48 | 64 | 80 | 96 | 112 |
| 0 | 0 | 20 | 40 | 60 | 80 | 100 | 120 | 140 |
| 1 | 1 | 21 | 21 | 31 | 41 | 51 | 61 | 71 |
| 1 | 1 | 17 | 33 | 49 | 65 | 81 | 97 | 113 |
| 1 | 1 | 21 | 41 | 61 | 81 | 101 | 121 | 141 |
| 2 | 2 | 12 | 22 | 32 | 42 | 52 | 62 | 72 |
| 2 | 2 | 18 | 34 | 50 | 66 | 82 | 98 | 114 |
| 2 | 2 | 22 | 42 | 62 | 82 | 102 | 122 | 142 |
| 3 | 3 | 13 | 23 | 33 | 43 | 53 | 63 | 73 |
| 3 | 3 | 19 | 35 | 51 | 67 | 83 | 99 | 115 |
| 3 | 3 | 23 | 43 | 63 | 83 | 103 | 123 | 143 |
| 4 | 4 | 14 | 24 | 34 | 44 | 54 | 64 | 74 |
| 4 | 4 | 20 | 36 | 52 | 68 | 84 | 100 | 116 |
| 4 | 4 | 24 | 44 | 64 | 84 | 104 | 124 | 144 |
| 5 | 5 | 15 | 25 | 35 | 45 | 55 | 65 | 75 |
| 5 | 5 | 21 | 37 | 53 | 69 | 85 | 101 | 117 |
| 5 | 5 | 25 | 45 | 65 | 85 | 105 | 125 | 145 |
| 6 | 6 | 16 | 26 | 36 | 46 | 56 | 66 | 76 |
| 6 | 6 | 22 | 38 | 54 | 70 | 86 | 102 | 118 |
| 6 | 6 | 26 | 46 | 66 | 86 | 106 | 126 | 146 |
| 7 | 7 | 17 | 27 | 37 | 47 | 57 | 67 | 77 |
| 7 | 7 | 23 | 39 | 55 | 71 | 87 | 103 | 119 |
| 7 | 7 | 27 | 47 | 67 | 87 | 107 | 127 | 147 |
| 8 | 8 | 18 | 28 | 38 | 48 | 58 | 68 | 78 |
| 8 | 8 | 24 | 40 | 56 | 72 | 88 | 104 | 120 |
| 8 | 8 | 30 | 50 | 70 | 90 | 110 | 130 | 150 |
| 9 | 9 | 19 | 29 | 39 | 49 | 59 | 69 | 79 |
| 9 | 9 | 25 | 41 | 57 | 73 | 89 | 105 | 121 |
| 9 | 9 | 31 | 51 | 71 | 91 | 111 | 131 | 151 |
| A | A | 1A | 2A | 3A | 4A | 5A | 6A | 7A |
| A | A | 10 | 26 | 42 | 58 | 74 | 90 | 106 |
| A | A | 12 | 32 | 48 | 64 | 80 | 96 | 112 |
| B | B | 1B | 2B | 3B | 4B | 5B | 6B | 7B |
| B | B | 11 | 27 | 43 | 59 | 75 | 91 | 107 |
| B | B | 13 | 33 | 49 | 65 | 81 | 97 | 113 |
| C | C | 1C | 2C | 3C | 4C | 5C | 6C | 7C |
| C | C | 12 | 28 | 44 | 60 | 76 | 92 | 108 |
| C | C | 14 | 34 | 50 | 66 | 82 | 98 | 114 |
| D | D | 1D | 2D | 3D | 4D | 5D | 6D | 7D |
| D | D | 13 | 29 | 45 | 61 | 77 | 93 | 109 |
| D | D | 15 | 35 | 51 | 67 | 83 | 99 | 115 |
| E | E | 1E | 2E | 3E | 4E | 5E | 6E | 7E |
| E | E | 14 | 30 | 46 | 62 | 78 | 94 | 110 |
| E | E | 16 | 36 | 52 | 68 | 84 | 100 | 116 |
| F | F | 1F | 2F | 3F | 4F | 5F | 6F | 7F |
| F | F | 15 | 31 | 47 | 63 | 79 | 95 | 111 |
| F | F | 17 | 37 | 53 | 69 | 85 | 101 | 117 |

3.2 - VT FAMILY

The VT220 emulation allows a 8-bit character set (256 characters) to be built from two 7-bit character sets (128 characters).

These 7-bit character sets are composed of 32 non-display control characters (called C0 and C1) and 94 display characters (called GL and GR).

A 8-bit character set is composed of:

- C0: control characters (ASCII codes from 00h to 1Fh),
- GL: graphic left (ASCII codes from 20h to 7Fh),
- C1: control characters (ASCII codes from 80h to 9Fh),
- GR: graphic right (ASCII codes from A0h to FFh).

The Platine terminal provides nine 7-bit character sets (described in the following pages):

- ASCII,
- 6 national replacement character sets (NRCs),
- DEC Multinational,
- DEC Special Graphic.

To use character sets, the following operations are performed:

- Map 4 character sets to the 4 available tables (G0, G1, G2 and G3).
- Map two tables (G0, G1, G2 or G3) to GL and GR.

When the AX3000 is switched on, the GL, GR, G0, G1, G2 and G3 tables are initialised according to the character set selected through the AX3000 Set-Up:

- **DEC Multinational:** GL and G0: ASCII set,
GR, G1, G2 and G3: DEC Multinational set.
- **National ISO 7-BIT:** GL and G0: NRCs (according to the
selected keyboard)
GR, G1, G2 and G3: unknown

The following diagram shows the mechanisms for designating and mapping character sets:

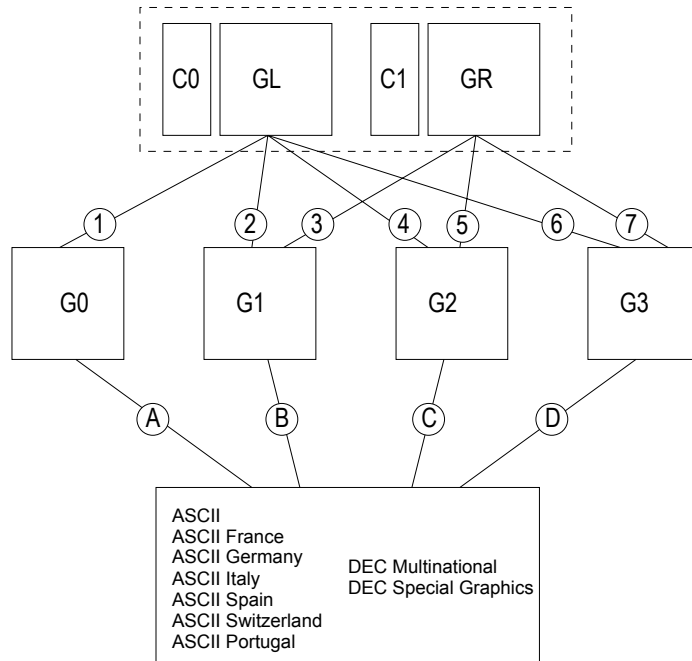

The following escape sequences are used to designate and map character sets (where x represents the character set code):

- | | |
|---------------------|-------------------|
| (A): Esc (x | (1): 0Fh |
| (B): Esc) x | (2): 0Eh |
| (C): Esc * x | (3): Esc ~ |
| (D): Esc + x | (4): Esc n |
| | (5): Esc } |
| | (6): Esc o |
| | (7): Esc |

x values: Ps = B (ASCII) Ps = R (French) Ps = < (DEC multinational)
 Ps = K (German) Ps = Y (Italian) Ps = 0 (DEC special graphics)
 Ps = Z (Spanish) Ps = = (Swiss) Ps = %6 (Portuguese)

The following describes the 9 available character sets (these sets can be mapped either to GL or GR):

ASCII
(C0 & GL)

| | 0 | 1 | 2 | 3 | 4 | 5 | 6 | 7 |
|---|-----|-----|----|---|---|---|---|---|
| 0 | NUL | DLE | SP | 0 | @ | P | ` | p |
| 1 | SOH | DC1 | ! | 1 | A | Q | a | q |
| 2 | STX | DC2 | " | 2 | B | R | b | r |
| 3 | ETX | DC3 | # | 3 | C | S | c | s |
| 4 | EOT | DC4 | \$ | 4 | D | T | d | t |
| 5 | ENQ | NAK | % | 5 | E | U | e | u |
| 6 | ACK | SYN | & | 6 | F | V | f | v |
| 7 | BEL | ETB | ' | 7 | G | W | g | w |
| 8 | BS | CAN | (| 8 | H | X | h | x |
| 9 | HT | EM |) | 9 | I | Y | i | y |
| A | LF | SUB | * | : | J | Z | j | z |
| B | VT | ESC | + | ; | K | [| k | { |
| C | FF | FS | , | < | L | \ | l | |
| D | CR | GS | - | = | M |] | m | } |
| E | SO | RS | . | > | N | ^ | n | ~ |
| F | SI | US | / | ? | O | _ | o | |

This table shows the characters in each NRC set that differ from the ASCII set:

| | Hexadecimal code of the replaced characters | | | | | | | | | | | |
|-------------|---|----|----|----|----|----|----|----|----|----|----|----|
| | 23 | 40 | 5B | 5C | 5D | 5E | 5F | 60 | 7B | 7C | 7D | 7E |
| France | £ | à | ° | ç | § | ^ | _ | ` | é | ù | è | ~ |
| U.K | £ | @ | [| \ |] | ^ | _ | ` | { | | } | ~ |
| Germany | # | § | Ä | Ö | Ü | ^ | _ | ` | ä | ö | ü | ß |
| Italy | £ | § | ° | ç | é | ^ | _ | ù | à | ò | è | i |
| Spain | £ | § | i | Ñ | ¿ | ^ | _ | ` | ° | ñ | ç | ~ |
| Switzerland | ù | à | é | ç | ê | î | è | ô | ä | ö | ü | û |
| Portugal | # | @ | Ã | Ç | Õ | ^ | _ | ` | ã | ç | õ | ~ |

DEC Multinational
(C1 & GR)

| | 8 | 9 | A | B | C | D | E | F | | | | | | | | |
|---|-----|------------------|-----|------------------|------------------|------------------|------------------|------------------|------------------|------------------|------------------|------------------|------------------|------------------|------------------|------------------|
| 0 | | 80 128 200 | DCS | 90 144 220 | A0 160 240 | ° | 90 176 260 | À | C0 192 300 | ¿ | D0 208 320 | à | E0 224 340 | ÿ | F0 240 360 | |
| 1 | | 81 129 201 | PU1 | 91 145 221 | ı | A1 161 241 | ± | B1 177 261 | Á | C1 193 301 | Ñ | D1 209 321 | á | E1 225 341 | ñ | F1 241 361 |
| 2 | | 82 130 202 | PU2 | 92 146 222 | ¢ | A2 162 242 | ² | B2 178 262 | Â | C2 194 302 | Ò | D2 210 322 | â | E2 226 342 | ò | F2 242 362 |
| 3 | | 83 131 203 | STS | 93 147 223 | £ | A3 163 243 | ³ | B3 179 263 | Ã | C3 195 303 | Ó | D3 211 323 | ã | E3 227 343 | ó | F3 243 363 |
| 4 | IND | 84 132 204 | CCH | 94 148 224 | ¥ | A4 164 244 | ¥ | B4 180 264 | Ä | C4 196 304 | Ö | D4 212 324 | ä | E4 228 344 | ö | F4 244 364 |
| 5 | NEL | 85 133 205 | MW | 95 149 225 | ¥ | A5 165 245 | µ | B5 181 265 | Å | C5 197 305 | Õ | D5 213 325 | å | E5 229 345 | õ | F5 245 365 |
| 6 | SSA | 86 134 206 | SPA | 96 150 226 | ¢ | A6 166 246 | ¶ | B6 182 266 | Æ | C6 198 306 | Ö | D6 214 326 | æ | E6 230 346 | ö | F6 246 366 |
| 7 | ESA | 87 135 207 | EPA | 97 151 227 | § | A7 167 247 | . | B7 183 267 | Ç | C7 199 307 | œ | D7 215 327 | ç | E7 231 347 | œ | F7 247 367 |
| 8 | HTS | 88 136 210 | | 98 152 230 | ¤ | A8 168 250 | ¸ | B8 184 270 | È | C8 200 310 | Ø | D8 216 330 | è | E8 232 350 | ø | F8 248 370 |
| 9 | HTJ | 89 137 211 | | 99 153 231 | © | A9 169 251 | ¹ | B9 185 271 | É | C9 201 311 | Ù | D9 217 331 | é | E9 233 351 | ù | F9 249 371 |
| A | VTS | 8A 138 212 | | 9A 154 232 | ª | AA 170 252 | º | BA 186 272 | Ê | CA 202 312 | Ú | DA 218 332 | ê | EA 234 352 | ú | FA 250 372 |
| B | PLD | 8B 139 213 | CSI | 9B 155 233 | « | AB 171 253 | » | BB 187 273 | Ë | CB 203 313 | Û | DB 219 333 | ë | EB 235 353 | û | FB 251 373 |
| C | PLU | 8C 140 214 | ST | 9C 156 234 | ¼ | AC 172 254 | ¼ | BC 188 274 | Ï | CC 204 314 | Ü | DC 220 334 | ï | EC 236 354 | ü | FC 252 374 |
| D | RI | 8D 141 215 | OSC | 9D 157 235 | ½ | AD 173 255 | ½ | BD 189 275 | Ì | CD 205 315 | Ý | DD 221 335 | ì | ED 237 355 | ÿ | FD 253 375 |
| E | SS2 | 8E 142 216 | PM | 9E 158 236 | ¾ | AE 174 256 | ¾ | BE 190 276 | Í | CE 206 316 | ÿ | DE 222 336 | í | EE 238 356 | ÿ | FE 254 376 |
| F | SS3 | 8F 143 217 | APC | 9F 159 237 | ¿ | AF 175 257 | ¿ | BF 191 277 | Î | CF 207 317 | ß | DF 223 337 | î | EF 239 357 | ÿ | FF 255 377 |

DEC Special Graphic
(C0 & GL)

| | 0 | 1 | 2 | 3 | 4 | 5 | 6 | 7 |
|---|-----|-----|----|---|---|---|---|---|
| 0 | NUL | DLE | SP | 0 | @ | P | ♦ | - |
| 1 | SOH | DC1 | ! | 1 | A | Q | ‡ | - |
| 2 | STX | DC2 | " | 2 | B | R | ‡ | - |
| 3 | ETX | DC3 | # | 3 | C | S | ‡ | - |
| 4 | EOT | DC4 | \$ | 4 | D | T | ‡ | |
| 5 | ENQ | NAK | % | 5 | E | U | ‡ | |
| 6 | ACK | SYN | & | 6 | F | V | ° | |
| 7 | BEL | ETB | ' | 7 | G | W | ± | |
| 8 | BS | CAN | (| 8 | H | X | ‡ | |
| 9 | HT | EM |) | 9 | I | Y | ‡ | ≤ |
| A | LF | SUB | * | : | J | Z | ‡ | ≥ |
| B | VT | ESC | + | ; | K | [| ‡ | Π |
| C | FF | FS | , | < | L | \ | ‡ | ≠ |
| D | CR | GS | - | = | M |] | ‡ | £ |
| E | SO | RS | . | > | N | ^ | ‡ | · |
| F | SI | US | / | ? | O | _ | ‡ | |

3.3 - WYSE FAMILY

The WYSE emulation allows a 8-bit character set (256 characters) to be built from two 7-bit character sets (128 characters). A 8-bit character set is composed of:

- a primary set (ASCII codes from 00h to 7Fh),
- a secondary set (ASCII codes from 80h to FFh),

The AX3000 provides seven 7-bit character sets (described in the following pages):

- Native Mode, - PC Equivalent - Graphics 1
- Multinational - Graphics 2 - Graphics 3
- Standard ASCII

To use character sets, the following operations are performed:

- Map 4 character sets to the 4 available banks (0 to 3).
- Map two banks to the primary and the secondary sets.

When the AX3000 is switched on, the primary and the secondary sets are initialised according to the character set selected through the Terminal Set-Up:

- **WYSE 60**: primary set = native mode, secondary set = multinational.
- **National ISO 7-BIT**: primary set = native mode.

The following diagram shows the mechanisms for designating and mapping character sets:

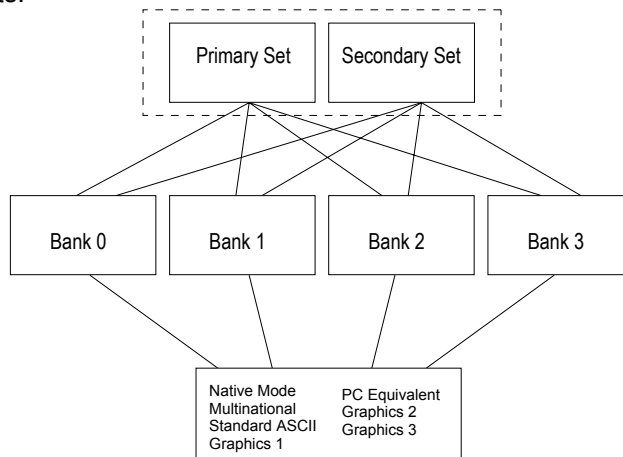

Native Mode

| | 0 | 1 | 2 | 3 | 4 | 5 | 6 | 7 |
|---|----|--------|----------|---------|---------|---------|---------|---------|
| 0 | | 0 T | 10 SP | 20 0 | 30 @ | 40 P | 50 , | 60 p |
| 1 | SH | 1 L | 11 ! | 21 1 | 31 A | 41 Q | 51 a | 61 q |
| 2 | SX | 2 r | 12 " | 22 2 | 32 B | 42 R | 52 b | 62 r |
| 3 | EX | 3 t | 13 # | 23 3 | 33 C | 43 S | 53 c | 63 s |
| 4 | ET | 4 f | 14 \$ | 24 4 | 34 D | 44 T | 54 d | 64 t |
| 5 | EQ | 5 j | 15 % | 25 5 | 35 E | 45 U | 55 e | 65 u |
| 6 | AK | 6 l | 16 & | 26 6 | 36 F | 46 V | 56 f | 66 v |
| 7 | BL | 7 █ | 17 ' | 27 7 | 37 G | 47 W | 57 g | 67 w |
| 8 | BS | 8 t | 18 (| 28 8 | 38 H | 48 X | 58 h | 68 x |
| 9 | HT | 9 t | 19) | 29 9 | 39 I | 49 Y | 59 i | 69 y |
| A | LF | A - | 1A * | 2A : | 3A J | 4A Z | 5A j | 6A z |
| B | VT | B █ | 1B + | 2B ; | 3B K | 4B [| 5B k | 6B { |
| C | FF | C = | 1C , | 2C < | 3C L | 4C \ | 5C l | 6C |
| D | CR | D ␣ | 1D - | 2D = | 3D M | 4D] | 5D m | 6D } |
| E | SO | E | 1E . | 2E > | 3E N | 4E ^ | 5E n | 6E ~ |
| F | SI | F █ | 1F / | 2F ? | 3F O | 4F _ | 5F o | 6F _ |

Multinational

| | 0 | 1 | 2 | 3 | 4 | 5 | 6 | 7 |
|---|---|----|---|----|----|----|---|---|
| 0 | Ç | É | á | █ | L | ll | α | ≡ |
| 1 | ü | æ | í | █ | l | ll | β | ± |
| 2 | é | Æ | ó | █ | T | ll | Γ | ≥ |
| 3 | â | ô | ú | | f | ll | π | ≤ |
| 4 | ä | ö | ñ | | - | ll | Σ | |
| 5 | à | ò | Ñ | f | + | F | σ | J |
| 6 | ã | û | ã | ll | f | ll | μ | ÷ |
| 7 | ç | ù | ø | ll | ll | ll | τ | ≈ |
| 8 | ê | ÿ | ç | ll | ll | ll | φ | ° |
| 9 | ë | Ö | ç | ll | ll | J | ⊙ | · |
| A | è | Ü | ç | ll | ll | ll | Ω | · |
| B | ï | ç | ½ | ll | ll | ll | δ | √ |
| C | î | £ | ¼ | ll | ll | ll | ∞ | n |
| D | ì | ¥ | i | ll | = | ll | φ | 2 |
| E | Ä | Pl | « | ll | ll | ll | ε | ■ |
| F | Å | f | » | ll | ll | ll | ∩ | ■ |

PC Equiv.

| | 0 | 1 | 2 | 3 | 4 | 5 | 6 | 7 | |
|---|---------------|----------------|----|----------------|----------------------|----------------------|----------------------|-----------------------|-----------------------|
| 0 | 0 0 | 10 16 20 | SP | 20 32 40 | 0 30 48 60 | @ 40 64 100 | P 50 80 120 | ` 60 96 140 | p 70 112 160 |
| 1 | 1 1 | 11 17 21 | ! | 21 31 33 | 1 31 49 61 | A 41 65 101 | Q 51 81 121 | a 61 97 141 | q 71 113 161 |
| 2 | 2 2 | 12 18 22 | " | 22 34 42 | 2 32 50 62 | B 42 66 102 | R 52 82 122 | b 62 98 142 | r 72 114 162 |
| 3 | 3 3 | 13 19 23 | # | 23 35 43 | 3 33 51 63 | C 43 67 103 | S 53 83 123 | c 63 99 143 | s 73 115 163 |
| 4 | 4 4 | 14 20 24 | \$ | 24 36 44 | 4 34 52 64 | D 44 68 104 | T 54 84 124 | d 64 100 144 | t 74 116 164 |
| 5 | 5 5 | 15 21 25 | % | 25 37 45 | 5 35 53 65 | E 45 69 105 | U 55 85 125 | e 65 101 145 | u 75 117 165 |
| 6 | 6 6 | 16 22 26 | & | 26 38 46 | 6 36 54 66 | F 46 70 106 | V 56 86 126 | f 66 102 146 | v 76 118 166 |
| 7 | 7 7 | 17 23 27 | ' | 27 39 47 | 7 37 55 67 | G 47 71 107 | W 57 87 127 | g 67 103 147 | w 77 119 167 |
| 8 | 8 8 | 18 24 30 | (| 28 40 50 | 8 38 56 70 | H 48 72 110 | X 58 88 130 | h 68 104 150 | x 78 120 170 |
| 9 | 9 9 | 19 25 31 |) | 29 41 51 | 9 39 57 71 | I 49 73 111 | Y 59 89 131 | i 69 105 151 | y 79 121 171 |
| A | A 10 12 | 1A 26 32 | * | 2A 42 52 | 10 3A 59 72 | J 4A 74 112 | Z 5A 85 132 | j 6A 96 142 | z 7A 122 172 |
| B | B 11 13 | 1B 27 33 | + | 2B 43 53 | 11 3B 61 73 | K 4B 75 113 | [5B 89 133 | k 6B 107 153 | { 7B 123 173 |
| C | C 12 14 | 1C 28 34 | , | 2C 44 54 | 12 3C 62 74 | L 4C 76 114 | \ 5C 90 134 | l 6C 108 154 | 7C 124 174 |
| D | D 13 15 | 1D 29 35 | - | 2D 45 55 | 13 3D 63 75 | M 4D 77 115 |] 5D 91 135 | m 6D 109 155 | } 7D 125 175 |
| E | E 14 16 | 1E 30 36 | . | 2E 46 56 | 14 3E 64 76 | N 4E 78 116 | ^ 5E 92 136 | n 6E 110 156 | ~ 7E 126 176 |
| F | F 15 17 | 1F 31 37 | / | 2F 47 57 | 15 3F 65 77 | O 4F 79 117 | _ 5F 93 137 | o 6F 111 157 | 7F 127 177 |

ASCII std.

| | 0 | 1 | 2 | 3 | 4 | 5 | 6 | 7 | |
|---|---------------------|----------------|----|----------------|----------------------|----------------------|----------------------|-----------------------|-----------------------|
| 0 | 0 0 | 10 16 20 | SP | 20 32 40 | 0 30 48 60 | @ 40 64 100 | P 50 80 120 | ` 60 96 140 | p 70 112 160 |
| 1 | SH 1 1 | 11 17 21 | ! | 21 31 41 | 1 31 49 61 | A 41 65 101 | Q 51 81 121 | a 61 97 141 | q 71 113 161 |
| 2 | SX 2 2 | 12 18 22 | " | 22 34 42 | 2 32 50 62 | B 42 66 102 | R 52 82 122 | b 62 98 142 | r 72 114 162 |
| 3 | EX 3 3 | 13 19 23 | # | 23 35 43 | 3 33 51 63 | C 43 67 103 | S 53 83 123 | c 63 99 143 | s 73 115 163 |
| 4 | ET 4 4 | 14 20 24 | \$ | 24 36 44 | 4 34 52 64 | D 44 68 104 | T 54 84 124 | d 64 100 144 | t 74 116 164 |
| 5 | EQ 5 5 | 15 21 25 | % | 25 37 45 | 5 35 53 65 | E 45 69 105 | U 55 85 125 | e 65 101 145 | u 75 117 165 |
| 6 | AK 6 6 | 16 22 26 | & | 26 38 46 | 6 36 54 66 | F 46 70 106 | V 56 86 126 | f 66 102 146 | v 76 118 166 |
| 7 | BL 7 7 | 17 23 27 | ' | 27 39 47 | 7 37 55 67 | G 47 71 107 | W 57 87 127 | g 67 103 147 | w 77 119 167 |
| 8 | BS 8 8 | 18 24 30 | (| 28 40 50 | 8 38 56 70 | H 48 72 110 | X 58 88 130 | h 68 104 150 | x 78 120 170 |
| 9 | HT 9 9 | 19 25 31 |) | 29 41 51 | 9 39 57 71 | I 49 73 111 | Y 59 89 131 | i 69 105 151 | y 79 121 171 |
| A | LF A 10 12 | 1A 26 32 | * | 2A 42 52 | 10 3A 59 72 | J 4A 74 112 | Z 5A 85 132 | j 6A 96 142 | z 7A 122 172 |
| B | VT B 11 13 | 1B 27 33 | + | 2B 43 53 | 11 3B 61 73 | K 4B 75 113 | [5B 89 133 | k 6B 107 153 | { 7B 123 173 |
| C | FF C 12 14 | 1C 28 34 | , | 2C 44 54 | 12 3C 62 74 | L 4C 76 114 | \ 5C 90 134 | l 6C 108 154 | 7C 124 174 |
| D | CR D 13 15 | 1D 29 35 | - | 2D 45 55 | 13 3D 63 75 | M 4D 77 115 |] 5D 91 135 | m 6D 109 155 | } 7D 125 175 |
| E | SO E 14 16 | 1E 30 36 | . | 2E 46 56 | 14 3E 64 76 | N 4E 78 116 | ^ 5E 92 136 | n 6E 110 156 | ~ 7E 126 176 |
| F | SI F 15 17 | 1F 31 37 | / | 2F 47 57 | 15 3F 65 77 | O 4F 79 117 | _ 5F 93 137 | o 6F 111 157 | 7F 127 177 |

Graphics 1

| | 0 | 1 | 2 | 3 | 4 | 5 | 6 | 7 |
|---|---------------|----------------|----------------|----------------------|------------------------|------------------------|-----------------------|-------------------------|
| 0 | 0 0 0 | 10 16 20 | 20 32 40 | 0 30 48 60 | 40 64 100 | 50 80 120 | 0 60 140 | 70 112 160 |
| 1 | 1 1 1 | 11 17 21 | 21 33 41 | 1 31 49 61 | 41 65 101 | 51 81 121 | 1 97 141 | 71 113 161 |
| 2 | 2 2 2 | 12 18 22 | 22 34 42 | 2 32 50 62 | 42 66 102 | 52 82 122 | 2 98 142 | 72 114 162 |
| 3 | 3 3 3 | 13 19 23 | 23 35 43 | 3 33 51 63 | 43 67 103 | 53 83 123 | 3 63 143 | 73 115 163 |
| 4 | 4 4 4 | 14 20 24 | 24 36 44 | 4 34 52 64 | 44 68 104 | 54 84 124 | 4 64 100 144 | 74 116 164 |
| 5 | 5 5 5 | 15 21 25 | 25 37 45 | 5 35 53 65 | 45 69 105 | 55 85 125 | 5 65 101 145 | 75 117 165 |
| 6 | 6 6 6 | 16 22 26 | 26 38 46 | 6 36 54 66 | 46 70 106 | 56 86 126 | 6 66 102 146 | 76 118 166 |
| 7 | 7 7 7 | 17 23 27 | 27 39 47 | 7 37 55 67 | 47 71 107 | 57 87 127 | 7 67 103 147 | 77 119 167 |
| 8 | 8 8 10 | 18 24 30 | 28 40 50 | 8 38 56 70 | 48 72 110 | 58 88 130 | 8 68 104 150 | 78 120 170 |
| 9 | 9 9 11 | 19 25 31 | 29 41 51 | 9 39 57 71 | 49 73 111 | 59 89 131 | 9 69 105 151 | 79 121 171 |
| A | A 10 12 | 1A 17 23 | 2A 32 42 | 3A 39 57 72 | 4A 64 112 | 5A 80 132 | J 6A 74 122 | 7A 109 172 |
| B | B 11 13 | 1B 18 24 | 2B 30 40 | 3B 36 54 73 | 4B 66 113 | 5B 81 133 | 7 6B 75 123 | 7B 107 153 |
| C | C 12 14 | 1C 19 25 | 2C 28 34 | 3C 33 51 74 | 4C 57 95 114 | 5C 82 124 134 | 7 6C 76 124 | 7C 108 154 174 |
| D | D 13 15 | 1D 20 26 | 2D 29 35 | 3D 36 54 75 | 4D 61 99 115 | 5D 83 125 135 | L 6D 77 125 | 7D 109 155 175 |
| E | E 14 16 | 1E 21 27 | 2E 29 37 | 3E 36 54 76 | 4E 62 100 116 | 5E 84 126 136 | 7 6E 78 126 | 7E 110 156 176 |
| F | F 15 17 | 1F 22 28 | 2F 30 38 | 3F 33 51 77 | 4F 57 95 117 | 5F 85 127 137 | 7 6F 79 127 | 7F 111 157 177 |

Graphics 2

| | 0 | 1 | 2 | 3 | 4 | 5 | 6 | 7 |
|---|---------------|----------------|----------------|----------------------|------------------------|------------------------|------------------|------------------|
| 0 | 0 0 0 | 10 16 20 | 20 32 40 | 30 48 60 | 40 64 100 | 50 80 120 | 60 96 140 | 70 112 160 |
| 1 | 1 1 1 | 11 17 21 | 21 33 41 | 31 49 61 | 41 65 101 | 51 81 121 | 61 97 141 | 71 113 161 |
| 2 | 2 2 2 | 12 18 22 | 22 34 42 | 32 50 62 | 42 66 102 | 52 82 122 | 62 98 142 | 72 114 162 |
| 3 | 3 3 3 | 13 19 23 | 23 35 43 | 33 51 63 | 43 67 103 | 53 83 123 | 63 99 143 | 73 115 163 |
| 4 | 4 4 4 | 14 20 24 | 24 36 44 | 34 52 64 | 44 68 104 | 54 84 124 | 64 100 144 | 74 116 164 |
| 5 | 5 5 5 | 15 21 25 | 25 37 45 | 35 53 65 | 45 69 105 | 55 85 125 | 65 101 145 | 75 117 165 |
| 6 | 6 6 6 | 16 22 26 | 26 38 46 | 36 54 66 | 46 70 106 | 56 86 126 | 66 102 146 | 76 118 166 |
| 7 | 7 7 7 | 17 23 27 | 27 39 47 | 37 55 67 | 47 71 107 | 57 87 127 | 67 103 147 | 77 119 167 |
| 8 | 8 8 10 | 18 24 30 | 28 40 50 | 38 56 70 | 48 72 110 | 58 88 130 | 68 104 150 | 78 120 170 |
| 9 | 9 9 11 | 19 25 31 | 29 41 51 | 39 57 71 | 49 73 111 | 59 89 131 | 69 105 151 | 79 121 171 |
| A | A 10 12 | 1A 17 23 | 2A 28 34 | 3A 36 54 72 | 4A 60 96 112 | 5A 80 132 | 6A 106 152 | 7A 122 172 |
| B | B 11 13 | 1B 18 24 | 2B 29 35 | 3B 36 54 73 | 4B 62 98 113 | 5B 81 133 | 6B 107 153 | 7B 123 173 |
| C | C 12 14 | 1C 19 25 | 2C 28 34 | 3C 33 51 74 | 4C 57 95 114 | 5C 82 124 134 | 6C 108 154 | 7C 124 174 |
| D | D 13 15 | 1D 20 26 | 2D 29 35 | 3D 36 54 75 | 4D 61 99 115 | 5D 83 125 135 | 6D 109 155 | 7D 125 175 |
| E | E 14 16 | 1E 21 27 | 2E 29 37 | 3E 36 54 76 | 4E 62 100 116 | 5E 84 126 136 | 6E 110 156 | 7E 126 176 |
| F | F 15 17 | 1F 22 28 | 2F 30 38 | 3F 33 51 77 | 4F 57 95 117 | 5F 85 127 137 | 6F 111 157 | 7F 127 177 |

Graphics 3

| | 0 | 1 | 2 | 3 | 4 | 5 | 6 | 7 |
|---|---------------|----------------|----------------|----------------|-----------------|-----------------|------------------|------------------|
| 0 | 0 0 0 | 10 16 20 | 20 32 40 | 30 48 60 | 40 64 100 | 50 80 120 | 60 96 140 | 70 112 160 |
| 1 | 1 1 1 | 11 17 21 | 21 33 41 | 31 49 61 | 41 65 101 | 51 81 121 | 61 97 141 | 71 113 161 |
| 2 | 2 2 2 | 12 18 22 | 22 34 42 | 32 50 62 | 42 66 102 | 52 82 122 | 62 98 142 | 72 114 162 |
| 3 | 3 3 3 | 13 19 23 | 23 35 43 | 33 51 63 | 43 67 103 | 53 83 123 | 63 99 143 | 73 115 163 |
| 4 | 4 4 4 | 14 20 24 | 24 36 44 | 34 52 64 | 44 68 104 | 54 84 124 | 64 100 144 | 74 116 164 |
| 5 | 5 5 5 | 15 21 25 | 25 37 45 | 35 53 65 | L 69 105 | 45 75 125 | 55 85 145 | 65 101 165 |
| 6 | 6 6 6 | 16 22 26 | 26 38 46 | 36 54 66 | 46 70 106 | 56 86 126 | 66 102 146 | 76 118 166 |
| 7 | 7 7 7 | 17 23 27 | 27 39 47 | 37 55 67 | 47 71 107 | 57 87 127 | 67 103 147 | 77 119 167 |
| 8 | 8 8 8 | 18 24 30 | 28 40 50 | 38 56 70 | 48 72 110 | 58 88 130 | 68 104 150 | 78 120 170 |
| 9 | 9 9 9 | 19 25 31 | 29 41 51 | 39 57 71 | 49 73 111 | 59 89 131 | 69 105 151 | 79 121 171 |
| A | A 10 12 | 1A 26 32 | 2A 42 52 | 3A 58 72 | 4A 74 112 | 5A 90 132 | 6A 106 152 | 7A 122 172 |
| B | B 11 13 | 1B 27 33 | 2B 43 53 | 3B 59 73 | 4B 75 113 | 5B 91 133 | 6B 107 153 | 7B 123 173 |
| C | C 12 14 | 1C 28 34 | 2C 44 54 | 3C 60 74 | 4C 76 114 | 5C 92 134 | 6C 108 154 | 7C 124 174 |
| D | D 13 15 | 1D 29 35 | 2D 45 55 | 3D 61 75 | 4D 77 115 | 5D 93 135 | 6D 109 155 | 7D 125 175 |
| E | E 14 16 | 1E 30 36 | 2E 46 56 | 3E 62 76 | 4E 78 116 | 5E 94 136 | 6E 110 156 | 7E 126 176 |
| F | F 15 17 | 1F 31 37 | 2F 47 57 | 3F 63 77 | 4F 79 117 | 5F 95 137 | 6F 111 157 | 7F 127 177 |

- 4 -
KEYBOARDS

This chapters provides a description of available national keyboards, a list of the default values for programming keys corresponding to the selected emulation and information about dead keys.

4.1 - NATIONAL KEYBOARDS

When a terminal is used in ASCII Mode, a national keyboard must be selected.

The AX3000 Platine terminal provides the following national keyboards:

- USA
- United Kingdom
- France
- Germany
- Spain
- Switzerland (German)
- Switzerland (French)
- Belgium
- Italy
- Portugal
- Netherlands

These 11 national keyboard layouts are described in the following.

U.S.A.

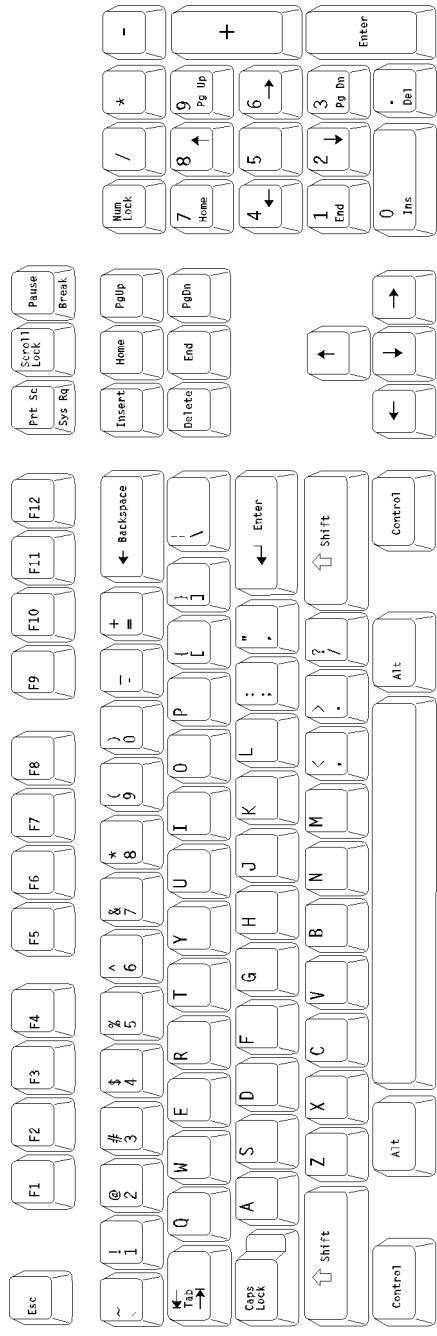

U.K.

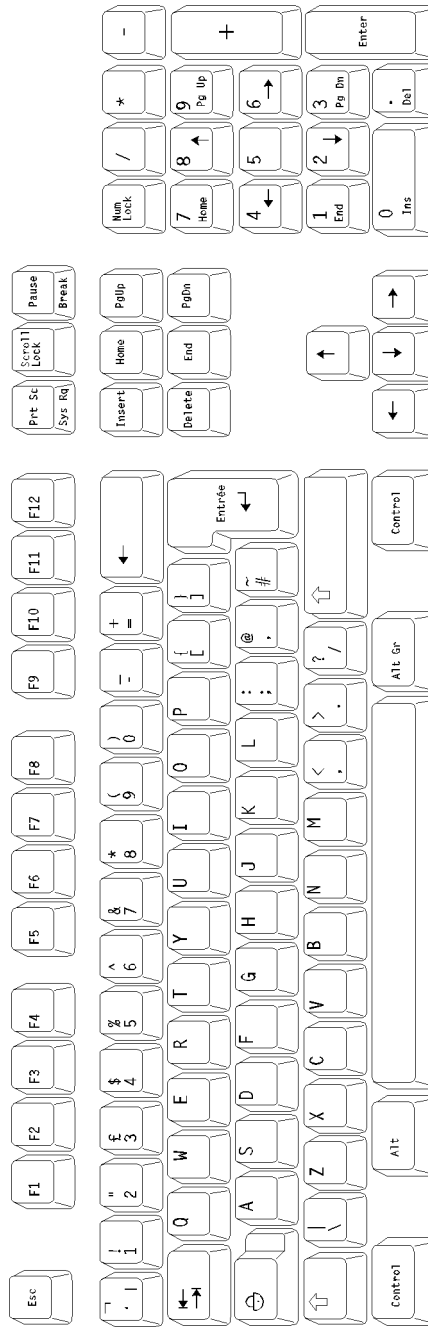

FRANCE

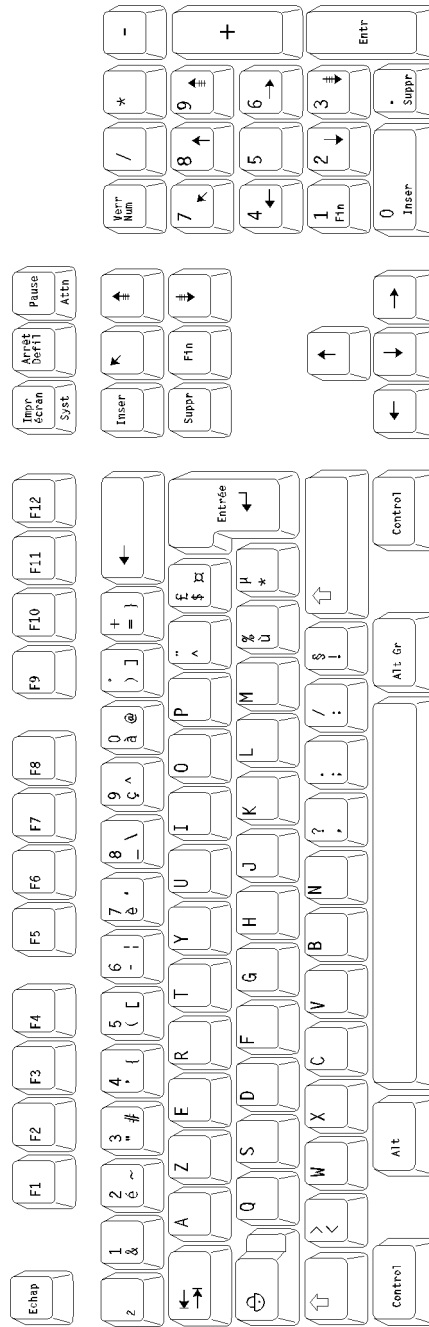

GERMANY

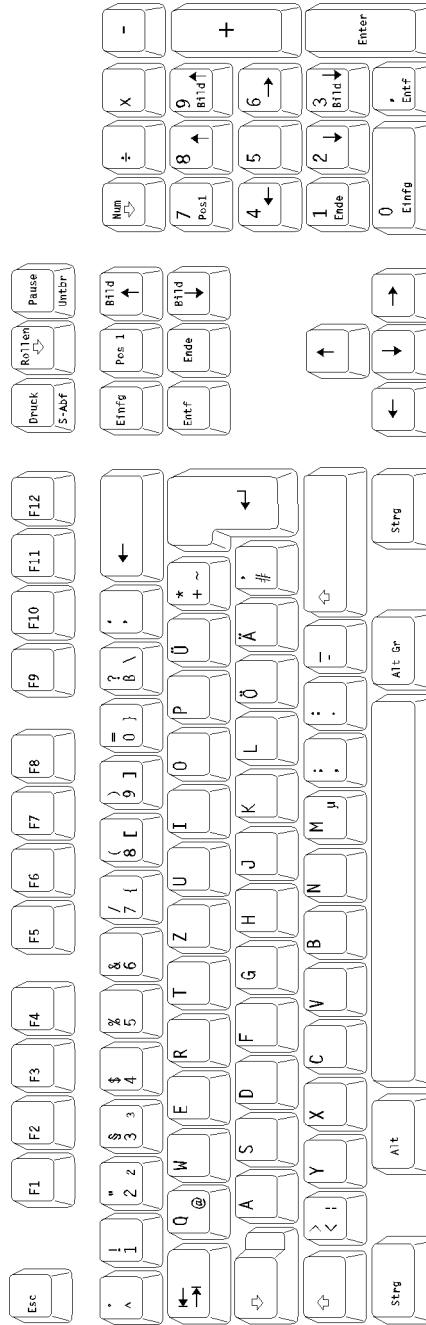

SWITZERLAND (French)

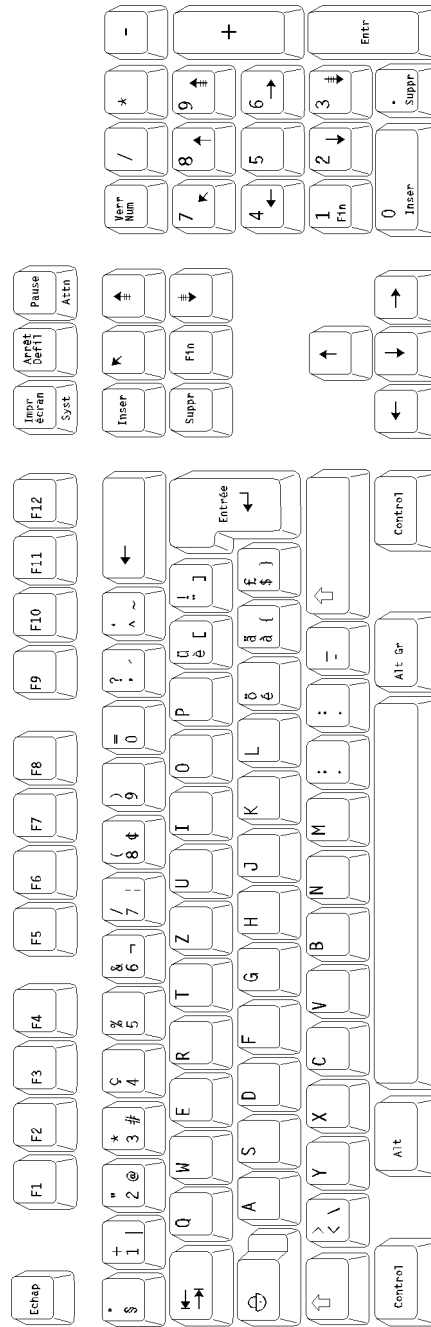

BELGIUM

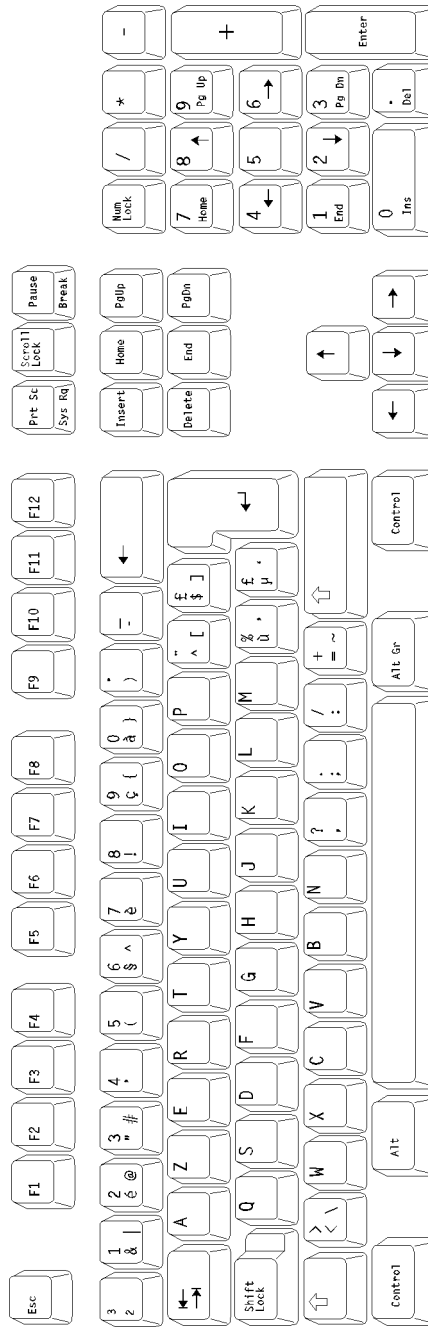

PORTUGAL

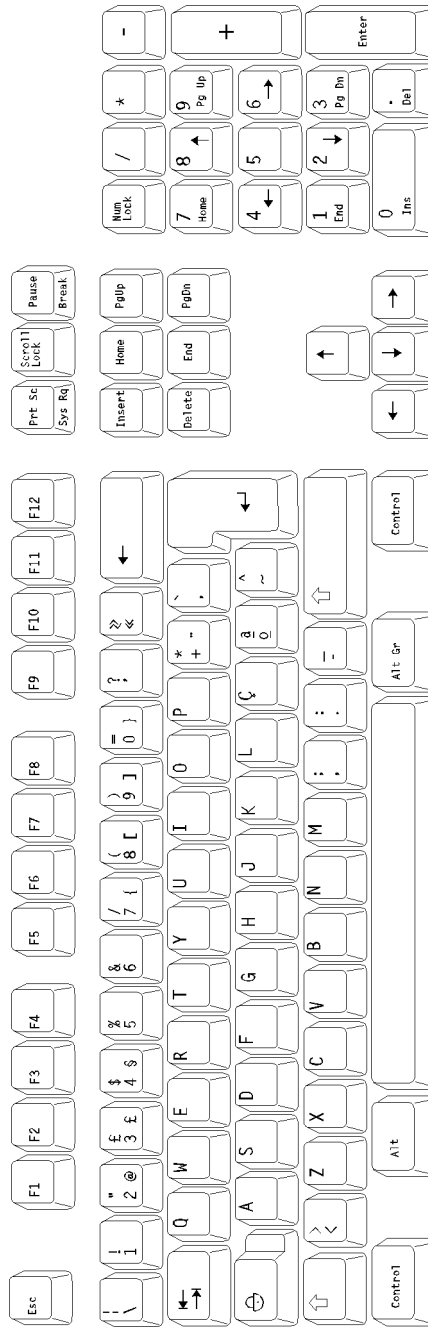

DUTCH

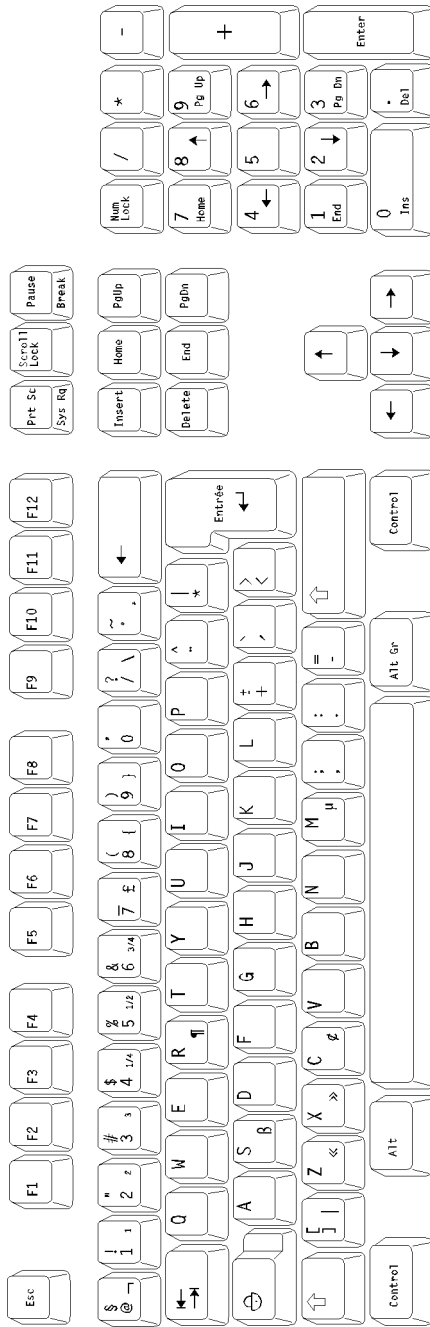

4.2 - PROGRAMMING KEYS

AX3000's built-in **Predefined Configuration** set-ups automatically set all standard terminal parameters to match the selected operating system.

Automatic configuration sets both the 'standard' terminal parameters (emulation, number of lines, screen modes, etc) and also the values of the available programming function keys.

Up to 62 programming keys (48 function keys plus the numeric keypad and escape) are updated in this way.

Function Key Memory Usage

Follow these two rules:

- do not exceed 32 characters, maximum, per function key string.
- Serial model: do not exceed 255 characters, in total, to encode all the function key strings.
- TCP/IP model: do not exceed 255 characters, per session, to encode all the function key strings. Sometimes, when you exit set-up, the Platine terminal will sound 5 'beeps'. This indicates insufficient memory for all the function key definitions.

Serial AX3000 Multi-Session

The ANSI, VT and WYSE families offer the multi-session capability (through the axmscreen software). Twelve dedicated keystrokes are needed for the multi-session.

Notes:

- the multi-session keystrokes can be changed through the AX3000 Set-Up.
- when a keystroke is redefined through the AX3000 Set-Up and also used by the multi-session, the multi-session feature has priority.

The following table gives the 12 multi-session default keystrokes and the associated values (these values can not be changed):

| label | Value | ANSI | VT, WYSE |
|-----------|---------|---------|----------|
| session 1 | Esc [<a | Alt+F1 | Ctrl+F1 |
| session 2 | Esc [<b | Alt+F2 | Ctrl+F2 |
| session 3 | Esc [<c | Alt+F3 | Ctrl+F3 |
| session 4 | Esc [<d | Alt+F4 | Ctrl+F4 |
| session 5 | Esc [<e | Alt+F5 | Ctrl+F5 |
| session 6 | Esc [<f | Alt+F6 | Ctrl+F6 |
| session 7 | Esc [<g | Alt+F7 | Ctrl+F7 |
| session 8 | Esc [<h | Alt+F8 | Ctrl+F8 |
| who | Esc [<i | Alt+F9 | Ctrl+F9 |
| help | Esc [<j | Alt+F10 | Ctrl+F10 |
| quit | Esc [<k | Alt+F11 | Ctrl+F11 |
| exit | Esc [<l | Alt+F12 | Ctrl+F12 |

TCP/IP AX3000 Multi-Session

No additional software is needed for the TCP/IP AX3000 multi-session. The default multi-session keystrokes are <Alt><Fx> (Fx represents whichever of the F1 to F12).

Notes:

- the multi-session keystrokes can be changed through the AX3000 Set-Up.
- when a keystroke is redefined through the AX3000 Set-Up and also used by the multi-session, the multi-session feature has priority.

Convention

in the following tables, the '**N**' column is the function key number (AX3000's set-up), the '**Keystroke**' column is the associated keystroke and the '**Value**' column is the corresponding default value.

4.2.1 - ANSI Family

ANSI, ANSI DOS, UNIX SCO 3.2.2, UNIX SCO 3.2.4, SCO OPENSERVEN and XENIX SCO

| N° | Keystroke | Value |
|-----|-----------|--------|
| F1 | F1 | Esc [M |
| F2 | F2 | Esc [N |
| F3 | F3 | Esc [O |
| F4 | F4 | Esc [P |
| F5 | F5 | Esc [Q |
| F6 | F6 | Esc [R |
| F7 | F7 | Esc [S |
| F8 | F8 | Esc [T |
| F9 | F9 | Esc [U |
| F10 | F10 | Esc [V |
| F11 | F11 | Esc [W |
| F12 | F12 | Esc [X |
| F13 | Shift+F1 | Esc [Y |
| F14 | Shift+F2 | Esc [Z |
| F15 | Shift+F3 | Esc [a |
| F16 | Shift+F4 | Esc [b |
| F17 | Shift+F5 | Esc [c |
| F18 | Shift+F6 | Esc [d |
| F19 | Shift+F7 | Esc [e |
| F20 | Shift+F8 | Esc [f |
| F21 | Shift+F9 | Esc [g |
| F22 | Shift+F10 | Esc [h |
| F23 | Shift+F11 | Esc [i |
| F24 | Shift+F12 | Esc [j |
| F25 | Ctrl+F1 | Esc [k |
| F26 | Ctrl+F2 | Esc [l |
| F27 | Ctrl+F3 | Esc [m |
| F28 | Ctrl+F4 | Esc [n |
| F29 | Ctrl+F5 | Esc [o |
| F30 | Ctrl+F6 | Esc [p |

| N° | Keystroke | Value |
|-----|----------------|---------|
| F31 | Ctrl+F7 | Esc [q |
| F32 | Ctrl+F8 | Esc [r |
| F33 | Ctrl+F9 | Esc [s |
| F34 | Ctrl+F10 | Esc [t |
| F35 | Ctrl+F11 | Esc [u |
| F36 | Ctrl+F12 | Esc [v |
| F37 | Ctrl+Shift+F1 | Esc [w |
| F38 | Ctrl+Shift+F2 | Esc [x |
| F39 | Ctrl+Shift+F3 | Esc [y |
| F40 | Ctrl+Shift+F4 | Esc [z |
| F41 | Ctrl+Shift+F5 | Esc [[|
| F42 | Ctrl+Shift+F6 | Esc [@ |
| F43 | Ctrl+Shift+F7 | Esc [\ |
| F44 | Ctrl+Shift+F8 | Esc [] |
| F45 | Ctrl+Shift+F9 | Esc [^ |
| F46 | Ctrl+Shift+F10 | Esc [_ |
| F47 | Ctrl+Shift+F11 | Esc [` |
| F48 | Ctrl+Shift+F12 | Esc [{ |
| F49 | <Home> | Esc [H |
| F50 | <Up> | Esc [A |
| F51 | <PgUp> | Esc [I |
| F52 | <-> | 2Dh |
| F53 | <Left> | Esc [D |
| F54 | <5> | Esc [E |
| F55 | <Right> | Esc [C |
| F56 | <+> | 2Bh |
| F57 | <End> | Esc [F |
| F58 | <Down> | Esc [B |
| F59 | <PgDn> | Esc [G |
| F60 | <Ins> | Esc [L |
| F61 | | 7Fh |
| F62 | <Esc> | 1Bh |

ANSI RS6000

| N° | Keystroke | Value |
|-----|-----------|-----------|
| F1 | F1 | Esc [001q |
| F2 | F2 | Esc [002q |
| F3 | F3 | Esc [003q |
| F4 | F4 | Esc [004q |
| F5 | F5 | Esc [005q |
| F6 | F6 | Esc [006q |
| F7 | F7 | Esc [007q |
| F8 | F8 | Esc [008q |
| F9 | F9 | Esc [009q |
| F10 | F10 | Esc [010q |
| F11 | F11 | Esc [011q |
| F12 | F12 | Esc [012q |
| F13 | Shift+F1 | Esc [013q |
| F14 | Shift+F2 | Esc [014q |
| F15 | Shift+F3 | Esc [015q |
| F16 | Shift+F4 | Esc [016q |
| F17 | Shift+F5 | Esc [017q |
| F18 | Shift+F6 | Esc [018q |
| F19 | Shift+F7 | Esc [019q |
| F20 | Shift+F8 | Esc [020q |
| F21 | Shift+F9 | Esc [021q |
| F22 | Shift+F10 | Esc [022q |
| F23 | Shift+F11 | Esc [023q |
| F24 | Shift+F12 | Esc [024q |
| F25 | Ctrl+F1 | Esc [025q |
| F26 | Ctrl+F2 | Esc [026q |
| F27 | Ctrl+F3 | Esc [027q |
| F28 | Ctrl+F4 | Esc [028q |
| F29 | Ctrl+F5 | Esc [029q |
| F30 | Ctrl+F6 | Esc [030q |

| N° | Keystroke | Value |
|-----|-----------|-----------|
| F31 | Ctrl+F7 | Esc [031q |
| F32 | Ctrl+F8 | Esc [032q |
| F33 | Ctrl+F9 | Esc [033q |
| F34 | Ctrl+F10 | Esc [034q |
| F35 | Ctrl+F11 | Esc [035q |
| F36 | Ctrl+F12 | Esc [036q |

| N° | Keystroke | Value |
|-----|-----------|-----------|
| F49 | <Home> | Esc [H |
| F50 | <Up> | Esc [A |
| F51 | <PgUp> | Esc [150q |
| F52 | <-> | 2Dh |
| F53 | <Left> | Esc [D |
| F54 | <5> | Esc [E |
| F55 | <Right> | Esc [C |
| F56 | <+> | 2Bh |
| F57 | <End> | Esc [146q |
| F58 | <Down> | Esc [B |
| F59 | <PgDn> | Esc [154q |
| F60 | <Ins> | Esc [139q |
| F61 | | 7Fh |
| F62 | <Esc> | 1Bh |

ANSI INTERACTIVE / UNIX SVR4 / UNIXWARE 7

| N° | Keystroke | Value |
|-----|-----------|--------|
| F1 | F1 | Esc OP |
| F2 | F2 | Esc OQ |
| F3 | F3 | Esc OR |
| F4 | F4 | Esc OS |
| F5 | F5 | Esc OT |
| F6 | F6 | Esc OU |
| F7 | F7 | Esc OV |
| F8 | F8 | Esc OW |
| F9 | F9 | Esc OX |
| F10 | F10 | Esc OY |
| F11 | F11 | Esc OZ |
| F12 | F12 | Esc OA |
| F13 | Shift+F1 | Esc Op |
| F14 | Shift+F2 | Esc Oq |
| F15 | Shift+F3 | Esc Or |
| F16 | Shift+F4 | Esc Os |
| F17 | Shift+F5 | Esc Ot |
| F18 | Shift+F6 | Esc Ou |
| F19 | Shift+F7 | Esc Ov |
| F20 | Shift+F8 | Esc Ow |
| F21 | Shift+F9 | Esc Ox |
| F22 | Shift+F10 | Esc Oy |
| F23 | Shift+F11 | Esc Oz |
| F24 | Shift+F12 | Esc Oa |
| F25 | Ctrl+F1 | Esc OP |
| F26 | Ctrl+F2 | Esc OQ |
| F27 | Ctrl+F3 | Esc OR |
| F28 | Ctrl+F4 | Esc OS |
| F29 | Ctrl+F5 | Esc OT |
| F30 | Ctrl+F6 | Esc OU |

| N° | Keystroke | Value |
|-----|----------------|--------|
| F31 | Ctrl+F7 | Esc OV |
| F32 | Ctrl+F8 | Esc OW |
| F33 | Ctrl+F9 | Esc OX |
| F34 | Ctrl+F10 | Esc OY |
| F35 | Ctrl+F11 | Esc OZ |
| F36 | Ctrl+F12 | Esc OA |
| F37 | Ctrl+Shift+F1 | 1Fh |
| F38 | Ctrl+Shift+F2 | --- |
| F39 | Ctrl+Shift+F3 | Esc Or |
| F40 | Ctrl+Shift+F4 | Esc Os |
| F41 | Ctrl+Shift+F5 | Esc Ot |
| F42 | Ctrl+Shift+F6 | Esc Ou |
| F43 | Ctrl+Shift+F7 | Esc Ov |
| F44 | Ctrl+Shift+F8 | Esc Ow |
| F45 | Ctrl+Shift+F9 | Esc Ox |
| F46 | Ctrl+Shift+F10 | Esc Oy |
| F47 | Ctrl+Shift+F11 | Esc Oz |
| F48 | Ctrl+Shift+F12 | Esc Oa |
| F49 | <Home> | Esc [H |
| F50 | <Up> | Esc [A |
| F51 | <PgUp> | Esc [V |
| F52 | <-> | Esc [S |
| F53 | <Left> | Esc [D |
| F54 | <5> | Esc [G |
| F55 | <Right> | Esc [C |
| F56 | <+> | Esc [T |
| F57 | <End> | Esc [Y |
| F58 | <Down> | Esc [B |
| F59 | <PgDn> | Esc [U |
| F60 | <Ins> | Esc [@ |
| F61 | | 7Fh |
| F62 | <Esc> | 1Bh |

Note: with Unixware 7, the <+> and <-> keys are associated with 2Bh (+) and 2Dh (-)

ANSI MOS

| N° | Keystroke | Value |
|-----|-----------|--------|
| F1 | F1 | Esc ' |
| F2 | F2 | Esc a |
| F3 | F3 | Esc b |
| F4 | F4 | Esc c |
| F5 | F5 | Esc d |
| F6 | F6 | Esc e |
| F7 | F7 | Esc f |
| F8 | F8 | Esc g |
| F9 | F9 | Esc h |
| F10 | F10 | Esc i |
| F11 | F11 | Esc j |
| F12 | F12 | Esc k |
| F13 | Shift+F1 | Esc p |
| F14 | Shift+F2 | Esc q |
| F15 | Shift+F3 | Esc r |
| F16 | Shift+F4 | Esc s |
| F17 | Shift+F5 | Esc t |
| F18 | Shift+F6 | Esc u |
| F19 | Shift+F7 | Esc v |
| F20 | Shift+F8 | Esc w |
| F21 | Shift+F9 | Esc x |
| F22 | Shift+F10 | Esc y |
| F23 | Shift+F11 | Esc z |
| F24 | Shift+F12 | Esc { |
| F25 | Ctrl+F1 | Esc [k |
| F26 | Ctrl+F2 | Esc [l |
| F27 | Ctrl+F3 | Esc [m |
| F28 | Ctrl+F4 | Esc [n |
| F29 | Ctrl+F5 | Esc [o |
| F30 | Ctrl+F6 | Esc [p |

| N° | Keystroke | Value |
|-----|----------------|---------|
| F31 | Ctrl+F7 | Esc [q |
| F32 | Ctrl+F8 | Esc [r |
| F33 | Ctrl+F9 | Esc [s |
| F34 | Ctrl+F10 | Esc [t |
| F35 | Ctrl+F11 | Esc [u |
| F36 | Ctrl+F12 | Esc [v |
| F37 | Ctrl+Shift+F1 | Esc [w |
| F38 | Ctrl+Shift+F2 | Esc [x |
| F39 | Ctrl+Shift+F3 | Esc [y |
| F40 | Ctrl+Shift+F4 | Esc [z |
| F41 | Ctrl+Shift+F5 | Esc [@ |
| F42 | Ctrl+Shift+F6 | Esc [[] |
| F43 | Ctrl+Shift+F7 | Esc [\ |
| F44 | Ctrl+Shift+F8 | Esc [] |
| F45 | Ctrl+Shift+F9 | Esc [^ |
| F46 | Ctrl+Shift+F10 | Esc [_ |
| F47 | Ctrl+Shift+F11 | Esc [` |
| F48 | Ctrl+Shift+F12 | Esc [{ |
| F49 | <Home> | Esc [H |
| F50 | <Up> | Esc [A |
| F51 | <PgUp> | Esc [I |
| F52 | <-> | 2Dh |
| F53 | <Left> | Esc [D |
| F54 | <5> | Esc [G |
| F55 | <Right> | Esc [C |
| F56 | <+> | 2Bh |
| F57 | <End> | Esc [F |
| F58 | <Down> | Esc [B |
| F59 | <PgDn> | Esc [G |
| F60 | <Ins> | Esc [L |
| F61 | | 7Fh |
| F62 | <Esc> | 1Bh |

LINUX

| N° | Touches | Valeur |
|-----|-----------|----------|
| F1 | F1 | Esc [[A |
| F2 | F2 | Esc [[B |
| F3 | F3 | Esc [[C |
| F4 | F4 | Esc [[D |
| F5 | F5 | Esc [[E |
| F6 | F6 | Esc [17~ |
| F7 | F7 | Esc [18~ |
| F8 | F8 | Esc [19~ |
| F9 | F9 | Esc [20~ |
| F10 | F10 | Esc [21~ |
| F11 | F11 | Esc [23~ |
| F12 | F12 | Esc [24~ |
| F13 | Shift+F1 | Esc [25~ |
| F14 | Shift+F2 | Esc [26~ |
| F15 | Shift+F3 | Esc [28~ |
| F16 | Shift+F4 | Esc [29~ |
| F17 | Shift+F5 | Esc [31~ |
| F18 | Shift+F6 | Esc [32~ |
| F19 | Shift+F7 | Esc [33~ |
| F20 | Shift+F8 | Esc [34~ |
| F21 | Shift+F9 | --- |
| F22 | Shift+F10 | --- |
| F23 | Shift+F11 | --- |
| F24 | Shift+F12 | --- |
| F25 | Ctrl+F1 | --- |
| F26 | Ctrl+F2 | --- |
| F27 | Ctrl+F3 | --- |
| F28 | Ctrl+F4 | --- |
| F29 | Ctrl+F5 | --- |
| F30 | Ctrl+F6 | --- |

| N° | Touches | Valeur |
|-----|----------------|---------|
| F31 | Ctrl+F7 | --- |
| F32 | Ctrl+F8 | --- |
| F33 | Ctrl+F9 | --- |
| F34 | Ctrl+F10 | --- |
| F35 | Ctrl+F11 | --- |
| F36 | Ctrl+F12 | --- |
| F37 | Ctrl+Shift+F1 | --- |
| F38 | Ctrl+Shift+F2 | --- |
| F39 | Ctrl+Shift+F3 | --- |
| F40 | Ctrl+Shift+F4 | --- |
| F41 | Ctrl+Shift+F5 | --- |
| F42 | Ctrl+Shift+F6 | --- |
| F43 | Ctrl+Shift+F7 | --- |
| F44 | Ctrl+Shift+F8 | --- |
| F45 | Ctrl+Shift+F9 | --- |
| F46 | Ctrl+Shift+F10 | --- |
| F47 | Ctrl+Shift+F11 | --- |
| F48 | Ctrl+Shift+F12 | --- |
| F49 | <Home> | Esc [1~ |
| F50 | <Haut> | Esc [A |
| F51 | <PgUp> | Esc [5~ |
| F52 | <-> | 2Dh |
| F53 | <Gauche> | Esc [D |
| F54 | <5> | Esc [G |
| F55 | <Droite> | Esc [C |
| F56 | <+> | 2Bh |
| F57 | <Fin> | Esc [4~ |
| F58 | <Bas> | Esc [B |
| F59 | <PgDn> | Esc [6~ |
| F60 | <Insert> | Esc [2~ |
| F61 | <Suppr> | 7Fh |
| F62 | <Esc> | 1Bh |

ANSI SLNET

| N° | Keystroke | Value |
|-----|-----------|-------------------------|
| F1 | F1 | 01h 31h |
| F2 | F2 | 01h 32h |
| F3 | F3 | 01h 33h |
| F4 | F4 | 01h 34h |
| F5 | F5 | 01h 35h |
| F6 | F6 | 01h 36h |
| F7 | F7 | 01h 37h |
| F8 | F8 | 01h 38h |
| F9 | F9 | 01h 39h |
| F10 | F10 | 01h 30h |
| F11 | F11 | 01h 2Dh |
| F12 | F12 | 01h 3Dh |
| F13 | Shift+F1 | 01h 73h 01h 31h 01h 73h |
| F14 | Shift+F2 | 01h 73h 01h 32h 01h 73h |
| F15 | Shift+F3 | 01h 73h 01h 33h 01h 73h |
| F16 | Shift+F4 | 01h 73h 01h 34h 01h 73h |
| F17 | Shift+F5 | 01h 73h 01h 35h 01h 73h |
| F18 | Shift+F6 | 01h 73h 01h 36h 01h 73h |
| F19 | Shift+F7 | 01h 73h 01h 37h 01h 73h |
| F20 | Shift+F8 | 01h 73h 01h 38h 01h 73h |
| F21 | Shift+F9 | 01h 73h 01h 39h 01h 73h |
| F22 | Shift+F10 | 01h 73h 01h 30h 01h 73h |
| F23 | Shift+F11 | 01h 73h 01h 2Dh 01h 73h |
| F24 | Shift+F12 | 01h 73h 01h 3Dh 01h 73h |

No default value is associated with other keystrokes:

- F25 to F35 (Ctrl+Fx)
- F36 to F48 (Ctrl+Shift+Fx)

Numeric Pad:

| N° | Keystroke | Value |
|-----|-----------|--------|
| F49 | <Home> | Esc [H |
| F50 | <Up> | Esc [A |
| F51 | <PgUp> | Esc [I |
| F52 | <-> | 2Dh |
| F53 | <Left> | Esc [D |
| F54 | <5> | Esc [G |
| F55 | <Right> | Esc [C |
| F56 | <+> | 2Bh |
| F57 | <End> | Esc [F |
| F58 | <Down> | Esc [B |
| F59 | <PgDn> | Esc [G |
| F60 | <Ins> | Esc [L |
| F61 | | 7Fh |
| F62 | <Esc> | 1Bh |

Edit Pad:

| Keystroke | Value |
|-----------|---------|
| Insert | 01h 69h |
| Home | 01h 68h |
| Page Up | 01h 75h |
| Delete | 01h 64h |
| End | 01h 65h |
| Page Down | 01h 6Eh |

Other keystrokes:

| Keystroke | Value |
|------------|---------|
| Control | 01h 63h |
| Alt | 01h 61h |
| Shitft Tab | 01h 74h |

ANSI DATA GENERAL

All the function key values are the same than the ANSI ones. The only difference is the <CR> value. These key sends 0Ah instead of 0Dh.

4.2.2 - VT Family

VT family is composed by the VT220, HFT and VT AS400 emulation.

VT220

Function keys:

| N° | Keystroke | Value |
|-----|-----------|----------|
| F1 | F1 | Esc OP |
| F2 | F2 | Esc OQ |
| F3 | F3 | Esc OR |
| F4 | F4 | Esc OS |
| F5 | F5 | Esc [16~ |
| F6 | F6 | Esc [17~ |
| F7 | F7 | Esc [18~ |
| F8 | F8 | Esc [19~ |
| F9 | F9 | Esc [20~ |
| F10 | F10 | Esc [21~ |
| F11 | F11 | Esc [23~ |
| F12 | F12 | Esc [24~ |
| F13 | Alt+F1 | Esc OP |
| F14 | Alt+F2 | Esc OQ |
| F15 | Alt+F3 | Esc OR |
| F16 | Alt+F4 | Esc OS |
| F17 | Alt+F5 | Esc [25~ |
| F18 | Alt+F6 | Esc [26~ |
| F19 | Alt+F7 | Esc [28~ |
| F20 | Alt+F8 | Esc [29~ |
| F21 | Alt+F9 | Esc [31~ |
| F22 | Alt+F10 | Esc [32~ |
| F23 | Alt+F11 | Esc [33~ |
| F24 | Alt+F12 | Esc [34~ |

| N° | Keystroke | Value |
|-----|---------------|-------|
| F25 | Shift+F1 | --- |
| F26 | Shift+F2 | --- |
| F27 | Shift+F3 | --- |
| F28 | Shift+F4 | --- |
| F29 | Shift+F5 | --- |
| F30 | Shift+F6 | --- |
| F31 | Shift+F7 | --- |
| F32 | Shift+F8 | --- |
| F33 | Shift+F9 | --- |
| F34 | Shift+F10 | --- |
| F35 | Shift+F11 | --- |
| F36 | Shift+F12 | --- |
| F37 | Alt+Shift+F1 | --- |
| F38 | Alt+Shift+F2 | --- |
| F39 | Alt+Shift+F3 | --- |
| F40 | Alt+Shift+F4 | --- |
| F41 | Alt+Shift+F5 | --- |
| F42 | Alt+Shift+F6 | --- |
| F43 | Alt+Shift+F7 | --- |
| F44 | Alt+Shift+F8 | --- |
| F45 | Alt+Shift+F9 | --- |
| F46 | Alt+Shift+F10 | --- |
| F47 | Alt+Shift+F11 | --- |
| F48 | Alt+Shift+F12 | --- |

The keypad modes (numeric or application) and the cursor keypad modes (cursor or application) are selected through escape sequences.

Numeric keypad:

| Key | Keypad Mode | | Application Mode |
|----------|-------------|-------------|------------------|
| | Locked | Unlocked | |
| <*> | * | * | Esc O1 |
| <-> | - | - | Esc Om |
| <.> | . | . | Esc On |
| <0> | 0 | Esc q | Esc Op |
| <1> | 1 | Esc [5~ | Esc Oq |
| <2> | 2 | Esc [B | Esc Or |
| <3> | 3 | Esc [U | Esc Os |
| <4> | 4 | Esc [D | Esc Ot |
| <5> | 5 | 5 | Esc Ou |
| <6> | 6 | Esc [C | Esc Ov |
| <7> | 7 | Esc [2~ | Esc Ow |
| <8> | 8 | Esc [A | Esc Ox |
| <9> | 9 | Esc [V | Esc Oy |
| <Return> | CR or CR+LF | CR or CR+LF | Esc OM |
| <+> | + | + | + |
| </> | / | / | / |

Cursor keypad:

| Key | Cursor Mode | Application Mode |
|---------|-------------|------------------|
| <Up> | Esc [A | Esc OA |
| <Down> | Esc [B | Esc OB |
| <Right> | Esc [C | Esc OC |
| <Left> | Esc [D | Esc OD |

Editing keypad:

| Key | Value |
|----------|---------|
| <Insert> | Esc [1~ |
| <Home> | Esc [2~ |
| <PgUp> | Esc [3~ |
| | Esc [4~ |
| <End> | Esc [5~ |
| <PgDn> | Esc [6~ |

HFT

Function keys:

| N° | Keystroke | Value |
|-----|-----------|-----------|
| F1 | F1 | Esc [001q |
| F2 | F2 | Esc [002q |
| F3 | F3 | Esc [003q |
| F4 | F4 | Esc [004q |
| F5 | F5 | Esc [005q |
| F6 | F6 | Esc [006q |
| F7 | F7 | Esc [007q |
| F8 | F8 | Esc [008q |
| F9 | F9 | Esc [009q |
| F10 | F10 | Esc [010q |
| F11 | F11 | Esc [011q |
| F12 | F12 | Esc [012q |
| F13 | Shift+F1 | Esc [013q |
| F14 | Shift+F2 | Esc [014q |
| F15 | Shift+F3 | Esc [015q |
| F16 | Shift+F4 | Esc [016q |
| F17 | Shift+F5 | Esc [017q |
| F18 | Shift+F6 | Esc [018q |
| F19 | Shift+F7 | Esc [019q |
| F20 | Shift+F8 | Esc [020q |
| F21 | Shift+F9 | Esc [021q |
| F22 | Shift+F10 | Esc [022q |
| F23 | Shift+F11 | Esc [023q |
| F24 | Shift+F12 | Esc [024q |
| F62 | Esc | 1Bh |

The following table lists the default value of the numeric keypad (or editing keypad and cursor keypad):

| N° | PS2 Keyboard | Value | 3270 Keyboard |
|-----|--------------|-----------|---------------|
| F49 | <Home> | Esc [H | home |
| F50 | <Up> | Esc [A | up |
| F51 | <Page Up> | Esc [150q | PA1 |
| F53 | <Left> | Esc [D | left |
| F55 | <Right> | Esc [C | right |
| F57 | <End> | Esc [146q | spaceof |
| F58 | <Down> | Esc [B | down |
| F59 | <PageDown> | Esc [154q | PA2 |
| F60 | <Insert> | Esc [139q | insert |
| F61 | | Esc [P | delete |

The following keystrokes are available in HFT emulation. It is not possible to modify their values:

| PS2 Keyboard | Value | 3270 Keyboard |
|----------------------|-----------|----------------|
| <Ctrl right> | Esc [114q | Send |
| <Scroll Lock> | Esc [213q | Repls |
| <Pause> | Esc [217q | Clear screen |
| <Print Screen> | Esc [209q | Print screen |
| <Alt><Print Screen> | Esc [212q | System request |
| <Shift><Scroll Lock> | Esc [214q | Saves |
| <Shift><Tab> | Esc [Z | Backtab |
| <Shift><Up> | Esc [161q | uup |
| <Shift><Down> | Esc [164q | ddown |
| <Shift><right> | Esc [167q | rright |
| <Shift><left> | Esc [158q | lleft |
| <Ctrl><Print Screen> | Esc [211q | Attention |
| <Ctrl><left> | Esc [159q | PA3 |

VT AS400

Function keys:

| N° | Keystroke | Value |
|-----|-----------|--------|
| F1 | F1 | Esc 1 |
| F2 | F2 | Esc 2 |
| F3 | F3 | Esc 3 |
| F4 | F4 | Esc 4 |
| F5 | F5 | Esc 5 |
| F6 | F6 | Esc 6 |
| F7 | F7 | Esc 7 |
| F8 | F8 | Esc 8 |
| F9 | F9 | Esc 9 |
| F10 | F10 | Esc 0 |
| F11 | F11 | Esc - |
| F12 | F12 | Esc = |
| F13 | Shift+F1 | Esc ! |
| F14 | Shift+F2 | Esc @ |
| F15 | Shift+F3 | Esc # |
| F16 | Shift+F4 | Esc \$ |
| F17 | Shift+F5 | Esc % |
| F18 | Shift+F6 | Esc ^ |
| F19 | Shift+F7 | Esc & |
| F20 | Shift+F8 | Esc * |
| F21 | Shift+F9 | Esc (|
| F22 | Shift+F10 | Esc) |
| F23 | Shift+F11 | Esc |
| F24 | Shift+F12 | Esc + |
| F62 | <Esc> | 1Bh |

The keypad modes (numeric or application) and the cursor keypad modes (cursor or application) are selected through escape sequences.

Numeric keypad:

| N° | Key | Keypad Mode | |
|-----|----------|-------------|-------------|
| | | Locked | Unlocked |
| --- | <*> | * | * |
| F52 | <-> | - | - |
| F61 | <.> | . | 7Fh |
| F60 | <0> | 0 | Esc q |
| F57 | <1> | 1 | Esc [5~ |
| F58 | <2> | 2 | Esc [B |
| F59 | <3> | 3 | Esc [U |
| F53 | <4> | 4 | Esc [D |
| F54 | <5> | 5 | 5 |
| F55 | <6> | 6 | Esc [C |
| F49 | <7> | 7 | Esc [2~ |
| F50 | <8> | 8 | Esc [A |
| F51 | <9> | 9 | Esc [V |
| --- | <Return> | CR or CR+LF | CR or CR+LF |
| F56 | <+> | + | + |
| --- | </> | / | / |

Cursor keypad:

| Key | Cursor Mode |
|---------|-------------|
| <Up> | Esc [A |
| <Down> | Esc [B |
| <Right> | Esc [C |
| <Left> | Esc [D |

Editing keypad:

| Key | Value |
|--------|--------|
| <Ins> | Esc I |
| <Home> | Ctrl O |
| <PgUp> | Ctrl U |
| | 7Fh |
| <End> | --- |
| <PgDn> | Ctrl F |

The following keystrokes are available in VT AS400 emulation. It is not possible to modify their values:

| Keystroke | Value | Label |
|------------------------------|---------|--------------------------|
| <Print Screen> | Esc P | Print |
| <Tab> | 09h | Field Avance |
| <Ctrl left> | Esc R | Error Reset |
| <Shift><F1> | Esc H | Help |
| <Shift><Return> | Esc 0Ah | New line |
| <Shift><Tab> | Esc 09h | Field Backspace |
| <Alt><Pause> | Esc A | Attention |
| <Alt><Print Screen> | Esc S | System request |
| <Alt><+> (numeric keypad) | Esc D | Duplicate |
| <Alt><-> (numeric keypad) | Esc M | Field Minus |
| <Alt><Home> (cursor keypad) | Ctrl E | Erase input |
| <Alt><Suppr> (cursor keypad) | Esc X | Field Exit |
| <Alt><Space> | Esc C | Clear screen |
| <Alt><Esc> | Ctrl T | Test Request |
| <Alt><Tab> | Esc T | Toggle indicators lights |
| <Alt><Return> | Esc L | Redraw screen |

4.2.3 - WYSE Emulation

| N° | Keystroke | Value |
|-----|-----------|-------------|
| F1 | F1 | 01h 40h 0Dh |
| F2 | F2 | 01h 41h 0Dh |
| F3 | F3 | 01h 42h 0Dh |
| F4 | F4 | 01h 43h 0Dh |
| F5 | F5 | 01h 44h 0Dh |
| F6 | F6 | 01h 45h 0Dh |
| F7 | F7 | 01h 46h 0Dh |
| F8 | F8 | 01h 47h 0Dh |
| F9 | F9 | 01h 48h 0Dh |
| F10 | F10 | 01h 49h 0Dh |
| F11 | F11 | 01h 4Ah 0Dh |
| F12 | F12 | 01h 4Bh 0Dh |
| F13 | Shift+F1 | 01h 60h 0Dh |
| F14 | Shift+F2 | 01h 61h 0Dh |
| F15 | Shift+F3 | 01h 62h 0Dh |
| F16 | Shift+F4 | 01h 63h 0Dh |
| F17 | Shift+F5 | 01h 64h 0Dh |
| F18 | Shift+F6 | 01h 65h 0Dh |
| F19 | Shift+F7 | 01h 66h 0Dh |
| F20 | Shift+F8 | 01h 67h 0Dh |
| F21 | Shift+F9 | 01h 68h 0Dh |
| F22 | Shift+F10 | 01h 69h 0Dh |
| F23 | Shift+F11 | 01h 6Ah 0Dh |
| F24 | Shift+F12 | 01h 6Bh 0Dh |
| F25 | Ctrl+F1 | --- |
| F26 | Ctrl+F2 | --- |
| F27 | Ctrl+F3 | --- |
| F28 | Ctrl+F4 | --- |
| F29 | Ctrl+F5 | --- |
| F30 | Ctrl+F6 | --- |

| N° | Keystroke | Value |
|-----|----------------|-------|
| F31 | Ctrl+F7 | --- |
| F32 | Ctrl+F8 | --- |
| F33 | Ctrl+F9 | --- |
| F34 | Ctrl+F10 | --- |
| F35 | Ctrl+F11 | --- |
| F36 | Ctrl+F12 | --- |
| F37 | Alt+F1 | --- |
| F38 | Alt+F2 | --- |
| F39 | Alt+F3 | --- |
| F40 | Alt+F4 | --- |
| F41 | Alt+F5 | --- |
| F42 | Alt+F6 | --- |
| F43 | Alt+F7 | --- |
| F44 | Alt+F8 | --- |
| F45 | Alt+F9 | --- |
| F46 | Alt+F10 | --- |
| F47 | Alt+F11 | --- |
| F48 | Alt+F12 | --- |
| F49 | <Home> | 1Eh |
| F50 | <Up> | 0Bh |
| F51 | <PgUp> | Esc J |
| F52 | <-> | 2Dh |
| F53 | <Left> | 08h |
| F54 | <5> | --- |
| F55 | <Right> | 0Ch |
| F56 | <+> | 2Bh |
| F57 | <End> | Esc T |
| F58 | <Down> | 0Ah |
| F59 | <PgDn> | Esc K |
| F60 | <Ins> | Esc q |
| F61 | (numpad) | 7Fh |
| | (edit) | Esc W |
| F62 | <Esc> | 1Bh |

4.2.4 - PCTERM Family

PCTERM, PCTERM THEOS, OS2 POLYMOD2

| N° | Keystroke | Value |
|-----|-----------|-------------|
| F1 | F1 | 01h 40h 0Dh |
| F2 | F2 | 01h 41h 0Dh |
| F3 | F3 | 01h 42h 0Dh |
| F4 | F4 | 01h 43h 0Dh |
| F5 | F5 | 01h 44h 0Dh |
| F6 | F6 | 01h 45h 0Dh |
| F7 | F7 | 01h 46h 0Dh |
| F8 | F8 | 01h 47h 0Dh |
| F9 | F9 | 01h 48h 0Dh |
| F10 | F10 | 01h 49h 0Dh |
| F11 | F11 | 01h 4Ah 0Dh |
| F12 | F12 | 01h 4Bh 0Dh |
| F13 | Shift+F1 | 01h 60h 0Dh |
| F14 | Shift+F2 | 01h 61h 0Dh |
| F15 | Shift+F3 | 01h 62h 0Dh |
| F16 | Shift+F4 | 01h 63h 0Dh |
| F17 | Shift+F5 | 01h 64h 0Dh |
| F18 | Shift+F6 | 01h 65h 0Dh |
| F19 | Shift+F7 | 01h 66h 0Dh |
| F20 | Shift+F8 | 01h 67h 0Dh |
| F21 | Shift+F9 | 01h 68h 0Dh |
| F22 | Shift+F10 | 01h 69h 0Dh |
| F23 | Shift+F11 | 01h 6Ah 0Dh |
| F24 | Shift+F12 | 01h 6Bh 0Dh |
| F25 | Ctrl+F1 | --- |
| F26 | Ctrl+F2 | --- |
| F27 | Ctrl+F3 | --- |
| F28 | Ctrl+F4 | --- |
| F29 | Ctrl+F5 | --- |
| F30 | Ctrl+F6 | --- |

| N° | Keystroke | Value |
|-----|-----------|-------|
| F31 | Ctrl+F7 | --- |
| F32 | Ctrl+F8 | --- |
| F33 | Ctrl+F9 | --- |
| F34 | Ctrl+F10 | --- |
| F35 | Ctrl+F11 | --- |
| F36 | Ctrl+F12 | --- |
| F37 | Alt+F1 | --- |
| F38 | Alt+F2 | --- |
| F39 | Alt+F3 | --- |
| F40 | Alt+F4 | --- |
| F41 | Alt+F5 | --- |
| F42 | Alt+F6 | --- |
| F43 | Alt+F7 | --- |
| F44 | Alt+F8 | --- |
| F45 | Alt+F9 | --- |
| F46 | Alt+F10 | --- |
| F47 | Alt+F11 | --- |
| F48 | Alt+F12 | --- |
| F49 | <Home> | 1Eh |
| F50 | <Up> | 0Bh |
| F51 | <PgUp> | Esc J |
| F52 | <-> | 2Dh |
| F53 | <Left> | 08h |
| F54 | <5> | --- |
| F55 | <Right> | 0Ch |
| F56 | <+> | 2Bh |
| F57 | <End> | Esc T |
| F58 | <Down> | 0Ah |
| F59 | <PgDn> | Esc K |
| F60 | <Ins> | Esc q |
| F61 | | 7Fh |
| F62 | <Esc> | 1Bh |

4.2.5 - SM94xx Family**SM9400**

| N° | Keystroke | Value |
|-----|-----------|-------|
| F1 | F1 | 96h |
| F2 | F2 | 90h |
| F3 | F3 | 12h |
| F4 | F4 | 93h |
| F5 | F5 | 9Ch |
| F6 | F6 | 1Bh |
| F7 | F7 | 0Ch |
| F8 | F8 | 95h |
| F9 | F9 | 1Fh |
| F10 | F10 | 17h |
| F11 | F11 | 8Eh |
| F12 | F12 | 91h |
| F13 | Shift+F1 | --- |
| F14 | Shift+F2 | --- |
| F15 | Shift+F3 | --- |
| F16 | Shift+F4 | --- |
| F17 | Shift+F5 | --- |
| F18 | Shift+F6 | --- |
| F19 | Shift+F7 | --- |
| F20 | Shift+F8 | --- |
| F21 | Shift+F9 | --- |
| F22 | Shift+F10 | --- |
| F23 | Shift+F11 | --- |
| F24 | Shift+F12 | --- |
| F25 | Ctrl+F1 | --- |
| F26 | Ctrl+F2 | --- |
| F27 | Ctrl+F3 | --- |
| F28 | Ctrl+F4 | --- |
| F29 | Ctrl+F5 | --- |
| F30 | Ctrl+F6 | --- |
| F31 | Ctrl+F7 | --- |
| F32 | Ctrl+F8 | --- |
| F33 | Ctrl+F9 | --- |
| F34 | Ctrl+F10 | --- |

| N° | Keystroke | Value |
|-----|----------------|-------|
| F35 | Ctrl+F11 | --- |
| F36 | Ctrl+F12 | --- |
| F37 | Ctrl+Shift+F1 | --- |
| F38 | Ctrl+Shift+F2 | --- |
| F39 | Ctrl+Shift+F3 | --- |
| F40 | Ctrl+Shift+F4 | --- |
| F41 | Ctrl+Shift+F5 | --- |
| F42 | Ctrl+Shift+F6 | --- |
| F43 | Ctrl+Shift+F7 | --- |
| F44 | Ctrl+Shift+F8 | --- |
| F45 | Ctrl+Shift+F9 | --- |
| F46 | Ctrl+Shift+F10 | --- |
| F47 | Ctrl+Shift+F11 | --- |
| F48 | Ctrl+Shift+F12 | --- |
| F49 | <Home> | 9Dh |
| F50 | <Up> | 1Ah |
| F51 | <PgUp> | 89h |
| F52 | <-> | 2Dh |
| F53 | <Left> | 19h |
| F54 | <5> | 35h |
| F55 | <Right> | 18h |
| F56 | <+> | 2Bh |
| F57 | <End> | 0Eh |
| F58 | <Down> | 0Bh |
| F59 | <PgDn> | 8Ah |
| F60 | <Ins> | 8Fh |
| F61 | | 8Dh |
| F62 | <Esc> | 1Bh |

| | |
|--------------------|-----|
| <Tab> | 09h |
| <Shift><Tab> | 14h |
| <backspace> | 08h |
| <Shift><backspace> | 7Fh |

SM9412

| N° | Keystroke | Value |
|-----|-----------|-------|
| F1 | F1 | 94h |
| F2 | F2 | 85h |
| F3 | F3 | 86h |
| F4 | F4 | 81h |
| F5 | F5 | 82h |
| F6 | F6 | 83h |
| F7 | F7 | 84h |
| F8 | F8 | 87h |
| F9 | F9 | 8Eh |
| F10 | F10 | 91h |
| F11 | F11 | 92h |
| F12 | F12 | 0Ah |
| F13 | Shift+F1 | 96h |
| F14 | Shift+F2 | 90h |
| F15 | Shift+F3 | 12h |
| F16 | Shift+F4 | 93h |
| F17 | Shift+F5 | 9Ch |
| F18 | Shift+F6 | 1Bh |
| F19 | Shift+F7 | 0Ch |
| F20 | Shift+F8 | 95h |
| F21 | Shift+F9 | 1Fh |
| F22 | Shift+F10 | 17h |
| F23 | Shift+F11 | 8Eh |
| F24 | Shift+F12 | 91h |
| F25 | Ctrl+F1 | E8h |
| F26 | Ctrl+F2 | --- |
| F27 | Ctrl+F3 | --- |
| F28 | Ctrl+F4 | --- |
| F29 | Ctrl+F5 | --- |
| F30 | Ctrl+F6 | --- |
| F31 | Ctrl+F7 | --- |
| F32 | Ctrl+F8 | EDh |
| F33 | Ctrl+F9 | --- |
| F34 | Ctrl+F10 | --- |
| F35 | Ctrl+F11 | 9Dh |
| F36 | Ctrl+F12 | 0Ah |

| N° | Keystroke | Value |
|-----|----------------|-------|
| F37 | Ctrl+Shift+F1 | --- |
| F38 | Ctrl+Shift+F2 | --- |
| F39 | Ctrl+Shift+F3 | --- |
| F40 | Ctrl+Shift+F4 | --- |
| F41 | Ctrl+Shift+F5 | --- |
| F42 | Ctrl+Shift+F6 | --- |
| F43 | Ctrl+Shift+F7 | --- |
| F44 | Ctrl+Shift+F8 | --- |
| F45 | Ctrl+Shift+F9 | --- |
| F46 | Ctrl+Shift+F10 | --- |
| F47 | Ctrl+Shift+F11 | --- |
| F48 | Ctrl+Shift+F12 | --- |
| F49 | <Home> | 9Dh |
| F50 | <Up> | 1Ah |
| F51 | <PgUp> | 89h |
| F52 | <-> | 2Dh |
| F53 | <Left> | 19h |
| F54 | <5> | 35h |
| F55 | <Right> | 18h |
| F56 | <+> | 2Bh |
| F57 | <End> | 0Eh |
| F58 | <Down> | 0Bh |
| F59 | <PgDn> | 8Ah |
| F60 | <Ins> | 8Fh |
| F61 | | 8Dh |
| F62 | <Esc> | 0Eh |

| | |
|--------------------|-----|
| <Shift><Esc> | 1Bh |
| <Ctrl><Esc> | EBh |
| <Tab> | 09h |
| <Shift><Tab> | 14h |
| <Ctrl><Tab> | 99h |
| <backspace> | 08h |
| <Shift><backspace> | 7Fh |

Numeric keypad:

| key | keypad | keypad Unlocked | |
|-----|--------|-----------------|-------------|
| | Locked | key alone | key + Shift |
| <7> | 37h | 37h | 85h 1Ah 81h |
| <8> | 38h | 38h | 1Ah |
| <9> | 39h | 39h | 85h 19h 81h |
| <4> | 34h | 34h | 19h |
| <5> | 35h | 35h | 35h |
| <6> | 36h | 36h | 18h |
| <1> | 31h | 31h | 85h 0Bh 81h |
| <2> | 32h | 32h | 0B |
| <3> | 33h | 33h | 85h 18h 81h |
| <0> | 30h | 30h | 8Fh |
| <.> | 2Eh | 2Eh | 8Dh |

Cursor keypad:

| | key | key + shift |
|---------|-----|-------------|
| <up> | 1Ah | 89h |
| <down> | 0Bh | 8Ah |
| <right> | 19h | 8Bh |
| <left> | 18h | 8Ch |

Editing keypad:

| key | Value |
|---------|-------------|
| <Inser> | 8Fh |
| <Home> | 83h 19h 81h |
| <PgUp> | 85h 19h 81h |
| | 8Dh |
| <End> | 83h 18h 81h |
| <PgDn> | 85h 18h 81h |

4.2.6 - PROLOGUE Family

PROLOGUE 2/3, PROLOGUE 4/5 and TWIN SERVER

| N° | Keystroke | Value |
|-----|-----------|-------------|
| F1 | F1 | 01h 80h 0Dh |
| F2 | F2 | 01h 81h 0Dh |
| F3 | F3 | 01h 82h 0Dh |
| F4 | F4 | 01h 83h 0Dh |
| F5 | F5 | 01h 84h 0Dh |
| F6 | F6 | 01h 85h 0Dh |
| F7 | F7 | 01h 86h 0Dh |
| F8 | F8 | 01h 87h 0Dh |
| F9 | F9 | 01h 88h 0Dh |
| F10 | F10 | 01h 89h 0Dh |
| F11 | Shift+F1 | 01h 8Ah 0Dh |
| F12 | Shift+F2 | 01h 8Bh 0Dh |
| F13 | Shift+F3 | 01h 8Ch 0Dh |
| F14 | Shift+F4 | 01h 8Dh 0Dh |
| F15 | Shift+F5 | 01h 8Eh 0Dh |
| F16 | Shift+F6 | 01h 8Fh 0Dh |
| F17 | Shift+F7 | 01h 90h 0Dh |
| F18 | Shift+F8 | 01h 91h 0Dh |
| F19 | Shift+F9 | 01h 92h 0Dh |
| F20 | Shift+F10 | 01h 93h 0Dh |
| F21 | Ctrl+F1 | 01h 94h 0Dh |
| F22 | Ctrl+F2 | 01h 95h 0Dh |
| F23 | Ctrl+F3 | 01h 96h 0Dh |
| F24 | Ctrl+F4 | 01h 97h 0Dh |
| F25 | Ctrl+F5 | 01h 98h 0Dh |
| F26 | Ctrl+F6 | 01h 99h 0Dh |
| F27 | Ctrl+F7 | 01h 9Ah 0Dh |
| F28 | Ctrl+F8 | 01h 9Bh 0Dh |
| F29 | Ctrl+F9 | 01h 9Ch 0Dh |
| F30 | Ctrl+F10 | 01h 9Dh 0Dh |

| N° | Keystroke | Value |
|-----|-----------|-------------|
| F31 | Alt+F1 | 01h 9Eh 0Dh |
| F32 | Alt+F2 | 01h 9Fh 0Dh |
| F33 | Alt+F3 | 01h A0h 0Dh |
| F34 | Alt+F4 | 01h A1h 0Dh |
| F35 | Alt+F5 | 01h A2h 0Dh |
| F36 | Alt+F6 | 01h A3h 0Dh |
| F37 | Alt+F7 | 01h A4h 0Dh |
| F38 | Alt+F8 | 01h A5h 0Dh |
| F39 | Alt+F9 | 01h A6h 0Dh |
| F40 | Alt+F10 | 01h A7h 0Dh |

| N° | Keystroke | Value |
|-----|-----------|-------|
| F49 | <Home> | 1Ch |
| F50 | <Up> | 0Bh |
| F51 | <PgUp> | 12h |
| F52 | <-> | 2Dh |
| F53 | <Left> | 08h |
| F54 | <5> | --- |
| F55 | <Right> | 06h |
| F56 | <+> | 2Bh |
| F57 | <End> | 02h |
| F58 | <Down> | 05h |
| F59 | <PgDn> | 03h |
| F60 | <Ins> | 0Fh |
| F61 | | 7Fh |
| F62 | <Esc> | 1Bh |

4.2.7 - QVT119+ Emulation

| N° | Keystroke | Value |
|-----|-----------|-------------|
| F1 | F1 | 01h 40h 0Dh |
| F2 | F2 | 01h 41h 0Dh |
| F3 | F3 | 01h 42h 0Dh |
| F4 | F4 | 01h 43h 0Dh |
| F5 | F5 | 01h 44h 0Dh |
| F6 | F6 | 01h 45h 0Dh |
| F7 | F7 | 01h 46h 0Dh |
| F8 | F8 | 01h 47h 0Dh |
| F9 | F9 | 01h 48h 0Dh |
| F10 | F10 | 01h 49h 0Dh |
| F11 | F11 | 01h 4Ah 0Dh |
| F12 | F12 | 01h 4Bh 0Dh |
| F13 | Shift+F1 | 01h 60h 0Dh |
| F14 | Shift+F2 | 01h 61h 0Dh |
| F15 | Shift+F3 | 01h 62h 0Dh |
| F16 | Shift+F4 | 01h 63h 0Dh |
| F17 | Shift+F5 | 01h 64h 0Dh |
| F18 | Shift+F6 | 01h 65h 0Dh |
| F19 | Shift+F7 | 01h 66h 0Dh |
| F20 | Shift+F8 | 01h 67h 0Dh |
| F21 | Shift+F9 | 01h 68h 0Dh |
| F22 | Shift+F10 | 01h 69h 0Dh |
| F23 | Shift+F11 | 01h 6Ah 0Dh |
| F24 | Shift+F12 | 01h 6Bh 0Dh |
| F25 | Ctrl+F1 | --- |
| F26 | Ctrl+F2 | --- |
| F27 | Ctrl+F3 | --- |
| F28 | Ctrl+F4 | --- |
| F29 | Ctrl+F5 | --- |
| F30 | Ctrl+F6 | --- |

| N° | Keystroke | Value |
|-----|----------------|-------|
| F31 | Ctrl+F7 | --- |
| F32 | Ctrl+F8 | --- |
| F33 | Ctrl+F9 | --- |
| F34 | Ctrl+F10 | --- |
| F35 | Ctrl+F11 | --- |
| F36 | Ctrl+F12 | --- |
| F37 | Ctrl+Shift+F1 | --- |
| F38 | Ctrl+Shift+F2 | --- |
| F39 | Ctrl+Shift+F3 | --- |
| F40 | Ctrl+Shift+F4 | --- |
| F41 | Ctrl+Shift+F5 | --- |
| F42 | Ctrl+Shift+F6 | --- |
| F43 | Ctrl+Shift+F7 | --- |
| F44 | Ctrl+Shift+F8 | --- |
| F45 | Ctrl+Shift+F9 | --- |
| F46 | Ctrl+Shift+F10 | --- |
| F47 | Ctrl+Shift+F11 | --- |
| F48 | Ctrl+Shift+F12 | --- |
| F49 | <Home> | 1Eh |
| F50 | <Up> | 0Bh |
| F51 | <PgUp> | Esc J |
| F52 | <-> | 2Dh |
| F53 | <Left> | 08h |
| F54 | <5> | 5 |
| F55 | <Right> | 0Ch |
| F56 | <+> | 2Bh |
| F57 | <End> | Esc T |
| F58 | <Down> | 0Ah |
| F59 | <PgDn> | Esc K |
| F60 | <Ins> | Esc r |
| F61 | | 7Fh |
| F62 | <Esc> | 1Bh |

4.2.8 - TVI Emulation

| N° | Keystroke | Value |
|-----|-----------|-------|
| F1 | F1 | 00h |
| F2 | F2 | 12h |
| F3 | F3 | 13h |
| F4 | F4 | 14h |
| F5 | F5 | 02h |
| F6 | F6 | 03h |
| F7 | F7 | 01h |
| F8 | F8 | 1Ch |
| F9 | F9 | 1Dh |
| F10 | F10 | 1Eh |
| F11 | F11 | 1Fh |
| F12 | F12 | 0Eh |
| F13 | Shift+F1 | 00h |
| F14 | Shift+F2 | 12h |
| F15 | Shift+F3 | 13h |
| F16 | Shift+F4 | 14h |
| F17 | Shift+F5 | 02h |
| F18 | Shift+F6 | 03h |
| F19 | Shift+F7 | 01h |
| F20 | Shift+F8 | 1Ch |
| F21 | Shift+F9 | 1Dh |
| F22 | Shift+F10 | 1Eh |
| F23 | Shift+F11 | 1Fh |
| F24 | Shift+F12 | 0Eh |
| F25 | Ctrl+F1 | --- |
| F26 | Ctrl+F2 | --- |
| F27 | Ctrl+F3 | --- |
| F28 | Ctrl+F4 | --- |
| F29 | Ctrl+F5 | --- |
| F30 | Ctrl+F6 | --- |

| N° | Keystroke | Value |
|-----|----------------|-------|
| F31 | Ctrl+F7 | --- |
| F32 | Ctrl+F8 | --- |
| F33 | Ctrl+F9 | --- |
| F34 | Ctrl+F10 | --- |
| F35 | Ctrl+F11 | --- |
| F36 | Ctrl+F12 | --- |
| F37 | Ctrl+Shift+F1 | --- |
| F38 | Ctrl+Shift+F2 | --- |
| F39 | Ctrl+Shift+F3 | --- |
| F40 | Ctrl+Shift+F4 | --- |
| F41 | Ctrl+Shift+F5 | --- |
| F42 | Ctrl+Shift+F6 | --- |
| F43 | Ctrl+Shift+F7 | --- |
| F44 | Ctrl+Shift+F8 | --- |
| F45 | Ctrl+Shift+F9 | --- |
| F46 | Ctrl+Shift+F10 | --- |
| F47 | Ctrl+Shift+F11 | --- |
| F48 | Ctrl+Shift+F12 | --- |
| F49 | <Home> | 1Eh |
| F50 | <Up> | 0Bh |
| F51 | <PgUp> | Esc J |
| F52 | <-> | 2Dh |
| F53 | <Left> | 08h |
| F54 | <5> | 5 |
| F55 | <Right> | 0Ch |
| F56 | <+> | 2Bh |
| F57 | <End> | Esc T |
| F58 | <Down> | 16h |
| F59 | <PgDn> | Esc K |
| F60 | <Ins> | Esc r |
| F61 | | 08h |
| F62 | <Esc> | 1Bh |

4.2.9 - 3151 Emulation

| N° | Keystroke | Value |
|-----|----------------|------------|
| F1 | F1 | Esc a 0Dh |
| F2 | F2 | Esc b 0Dh |
| F3 | F3 | Esc c 0Dh |
| F4 | F4 | Esc d 0Dh |
| F5 | F5 | Esc e 0Dh |
| F6 | F6 | Esc f 0Dh |
| F7 | F7 | Esc g 0Dh |
| F8 | F8 | Esc h 0Dh |
| F9 | F9 | Esc i 0Dh |
| F10 | F10 | Esc j 0Dh |
| F11 | F11 | Esc k 0Dh |
| F12 | F12 | Esc l 0Dh |
| F13 | Shift+F1 | Esc !a 0Dh |
| F14 | Shift+F2 | Esc !b 0Dh |
| F15 | Shift+F3 | Esc !c 0Dh |
| F16 | Shift+F4 | Esc !d 0Dh |
| F17 | Shift+F5 | Esc !e 0Dh |
| F18 | Shift+F6 | Esc !f 0Dh |
| F19 | Shift+F7 | Esc !g 0Dh |
| F20 | Shift+F8 | Esc !h 0Dh |
| F21 | Shift+F9 | Esc !i 0Dh |
| F22 | Shift+F10 | Esc !j 0Dh |
| F23 | Shift+F11 | Esc !k 0Dh |
| F24 | Shift+F12 | Esc !l 0Dh |
| F25 | Ctrl+Shift+F1 | Esc "a 0Dh |
| F26 | Ctrl+Shift+F2 | Esc "b 0Dh |
| F27 | Ctrl+Shift+F3 | Esc "c 0Dh |
| F28 | Ctrl+Shift+F4 | Esc "d 0Dh |
| F29 | Ctrl+Shift+F5 | Esc "e 0Dh |
| F30 | Ctrl+Shift+F6 | Esc "f 0Dh |
| F31 | Ctrl+Shift+F7 | Esc "g 0Dh |
| F32 | Ctrl+Shift+F8 | Esc "h 0Dh |
| F33 | Ctrl+Shift+F9 | Esc "i 0Dh |
| F34 | Ctrl+Shift+F10 | Esc "j 0Dh |
| F35 | Ctrl+Shift+F11 | Esc "k 0Dh |
| F36 | Ctrl+Shift+F12 | Esc "l 0Dh |

| N° | Keystroke | Value |
|-----|-----------|-----------|
| F37 | Ctrl+F1 | --- |
| F38 | Ctrl+F2 | --- |
| F39 | Ctrl+F3 | --- |
| F40 | Ctrl+F4 | --- |
| F41 | Ctrl+F5 | --- |
| F42 | Ctrl+F6 | --- |
| F43 | Ctrl+F7 | --- |
| F44 | Ctrl+F8 | --- |
| F45 | Ctrl+F9 | --- |
| F46 | Ctrl+F10 | --- |
| F47 | Ctrl+F11 | --- |
| F48 | Ctrl+F12 | --- |
| F49 | <Home> | Esc H |
| F50 | <Up> | Esc A |
| F51 | <PgUp> | Esc L 0Dh |
| F52 | <-> | 2Dh |
| F53 | <Left> | Esc D |
| F54 | <5> | 5 |
| F55 | <Right> | Esc C |
| F56 | <+> | 2Bh |
| F57 | <End> | Esc 2 |
| F58 | <Down> | Esc B |
| F59 | <PgDn> | Esc I |
| F60 | <Ins> | Esc P |
| F61 | | Esc Q |
| F62 | <Esc> | 1Bh |

| Non-programmables Keys | |
|------------------------|------------|
| <Shift><Tab> | Esc 2 |
| <Ctrl><1> (AP1) | Esc !m 0Dh |
| <Ctrl><2> (AP2) | Esc !n 0Dh |
| <Ctrl><3> (AP3) | Esc !o 0Dh |
| <Ctrl right> | Esc 8 0Dh |

4.3 - COMPOSITE CHARACTERS

To enter a composite character, two keystrokes are needed. The first one is the modifier (^, ~, ¨, etc), the second one is the character itself (a, e, i, n, etc).

Example: press '^' then 'e' to get 'ê'.

Note: on the AX3000, composite characters are accented characters.

When the keyboard is in scancode mode, composite characters are handled by the operating system.

When the keyboard is in ASCII mode, composite characters can be handled either by the AX3000 or by the operating system. Select either method using the 'Compose Characters' set-up parameter.

Three values are available for this set-up parameter:

- `no`: standard processing, to get accented characters, the operating system must map the keystroke pair to a single value,
- `local`: composite characters are locally processed by the AX3000,
- `remote`: special ASCII codes are associated with modifiers.

These three modes of processing are described in the following section. However note that the National ISO 7-bit character set is not covered, as it does not support composite characters.

4.3.1 - Standard Processing

When this method is used (Compose Characters: no), the AX3000 does not perform any special processing on the composite character modifier. The following table lists the ASCII codes, sent to the operating system, for the various character sets:

| | Character Sets | | | | | |
|-----------------------|----------------|--------|--------|------|-----|--------|
| | PC-437 | PC-85x | PC-860 | 8859 | DEC | SM9400 |
| Acute accent (´) | 27h | EFh | 27h | B4h | 27h | 27h |
| Grave accent (`) | 60h | 60h | 60h | 60h | 60h | 60h |
| Circumflex accent (^) | 5Eh | 5Eh | 5Eh | 5Eh | 5Eh | 5Eh |
| Dieresis (¨) | 22h | F9h | 22h | A8h | 22h | CEh |
| Tilde (~) | 7Eh | 7Eh | 7Eh | 7Eh | 7Eh | 7Eh |
| Paragraph (§) | 15h | F5h | 15h | A7h | A7h | C9h |
| Cube (³) | --- | FCh | --- | B3h | B3h | --- |
| Cedilla (,) | 2Ch | F7h | 2Ch | F7h | 2Ch | 2Ch |

Note: some symbols are not included in all characters sets. In such cases the AX3000 uses an ASCII code, to get a similar symbol. For example, with the character set 437, quotes are used for dieresis.

4.3.2 - Local Processing

When a composite character modifier is pressed (see table A.1) no character is sent to the operating system. The AX3000 waits for a second key to be pressed.

If the keystroke pair represents a valid symbol for the character set used (see table A.2), the ASCII code for this symbol is sent to the operating system.

If the symbol is not valid, a beep is sounded and the modifier is cancelled.

- Notes:**
- when the spacebar is pressed after the modifier, or when the modifier is pressed twice, the ASCII code sent to the operating system is the modifier itself (example: ^ + ^ = ^).
 - Some national keyboards (American, Italian and U.K.) do not support this feature.

| | FR | GE | SP | BE | SW | PO | DU |
|-----------------------|----|----|----|----|----|----|----|
| Acute accent (´) | | ✓ | ✓ | ✓ | ✓ | ✓ | ✓ |
| Grave accent (`) | | ✓ | ✓ | ✓ | ✓ | ✓ | ✓ |
| Circumflex accent (^) | ✓ | | ✓ | ✓ | ✓ | ✓ | ✓ |
| Dieresis (¨) | ✓ | | ✓ | ✓ | ✓ | ✓ | ✓ |
| Tilde (~) | | | | ✓ | ✓ | ✓ | ✓ |
| Cedilla (,) | | | | | | | ✓ |

Table A.1: valid modifiers for various national keyboards

| | Character Sets | | | | | |
|-----------------------|----------------|----------------|----------------|----------------|----------------|----------------|
| | PC-437 | PC-85x | PC-860 | 8859 | DEC | SM9400 |
| Acute accent (´) | áéíóú É | áéíóú ÁÉÍÓÚ | áéíóú ÁÉÍÓÚ | áéíóú ÁÉÍÓÚ | áéíóú ÁÉÍÓÚ | áéíóú ÁÉÍÓÚ |
| Grave accent (`) | àèìòù | àèìòù ÀÈÌÒÙ | àèìòù ÀÈÌÒÙ | àèìòù ÀÈÌÒÙ | àèìòù ÀÈÌÒÙ | àèìòù ÀÈÌÒÙ |
| Circumflex accent (^) | âêîôû | âêîôû ÂÊÎÔÛ | âêô ÂÊÔ | âêîôû ÂÊÎÔÛ | âêîôû ÂÊÎÔÛ | âêîôû ÂÊÎÔÛ |
| Dieresis (¨) | äëïöü ÄËÏÖÜ | äëïöü ÄËÏÖÜ | ü Ü | äëïöü ÄËÏÖÜ | äëïöü ÄËÏÖÜ | äëïöü ÄËÏÖÜ |
| Tilde (~) | ñ Ñ | ãðñ ÃÐÑ | ãðñ ÃÐÑ | ãðñ ÃÐÑ | ãðñ ÃÐÑ | ãðñ ÃÐÑ |
| Cedilla (,) | ç Ç | ç Ç | ç Ç | ç Ç | ç Ç | ç Ç |

Table A.2: valid symbols for the various modifiers and character sets

4.3.3 - Remote Processing

For this method, the operating system requires special ASCII codes to act as the modifiers of composite characters.

Note: as the paragraph symbol (§) and the cube symbol (³) are missing from some character sets, these two symbols also require special ASCII codes.

The tables on the next page list the ASCII codes required for the various national keyboards and character sets.

| France | Character Set | | | |
|-----------------------|---------------|--------|--------|------|
| | PC-437 | PC-85x | PC-860 | 8859 |
| Circumflex accent (^) | B0h | B0h | B0h | 90h |
| Dieresis (¨) | B1h | B1h | B1h | 91h |
| Paragraph (§) | B2h | F5h | B2h | A7h |
| Cube (³) | C0h | FCh | C0h | B3h |

| Germany | Character Set | | | |
|------------------|---------------|--------|--------|------|
| | PC-437 | PC-85x | PC-860 | 8859 |
| Acute accent (´) | B3h | B3h | B3h | 92h |
| Grave accent (`) | B4h | B4h | B4h | 93h |
| Paragraph (§) | B2h | F5h | B2h | A7h |
| Cube (³) | C0h | FCh | C0h | B3h |

| Italy | Character Set | | | |
|---------------|---------------|--------|--------|------|
| | PC-437 | PC-85x | PC-860 | 8859 |
| Paragraph (§) | B2h | F5h | B2h | A7h |
| Cube (³) | C0h | FCh | C0h | B3h |

| Spain | Character Set | | | |
|-----------------------|---------------|--------|--------|------|
| | PC-437 | PC-85x | PC-860 | 8859 |
| Acute accent (´) | B3h | B3h | B3h | 92h |
| Grave accent (`) | B4h | B4h | B4h | 93h |
| Circumflex accent (^) | B0h | B0h | B0h | 90h |
| Dieresis (¨) | B1h | B1h | B1h | 91h |
| Paragraph (§) | B2h | F5h | B2h | A7h |
| Cube (³) | C0h | FCh | C0h | B3h |

| Portugal / Switzerland Belgium / Netherlands | Character Set | | | |
|---|---------------|--------|--------|------|
| | PC-437 | PC-85x | PC-860 | 8859 |
| Acute accent (´) | B3h | B3h | B3h | 92h |
| Grave accent (`) | B4h | B4h | B4h | 93h |
| Circumflex accent (^) | B0h | B0h | B0h | 90h |
| Dieresis (¨) | B1h | B1h | B1h | 91h |
| Tilde (~) | 7Eh | B2h | 7Eh | 7Eh |
| Paragraph (§) | B2h | F5h | B2h | A7h |
| Cube (³) | C0h | FCh | C0h | B3h |

AXEL

16 Avenue du Québec
Bât. M1 EVOLIC - BP 728
91962 Courtabœuf cedex - FRANCE
Tel.: +33 1.69.28.27.27 - Fax: +33 1.69.28.82.04 - Email: info@axel.fr

